



Success made simple

The new standard for
hydraulic hose and fittings.



Powering Business Worldwide

Table of contents

Contents

Safety and Ordering Information	3
EATON WINNER HOSE	6
EC115 Wire Braided Hose 1SC	6
EC215 Wire Braided Hose 2SC	6
EC110 Wire Braided Hose 1SN	7
EC210 Wire Braided Hose 2SN	7
EC426 Spiral Hose 4SP	8
EC512 Spiral Hose 4SH	8
EC420 Spiral Hose R13	9
EC615 Spiral Hose R15	9
EATON WINNER TWO-PIECE BRAIDED HOSE FITTING	10
00110 Socket (EC115, EC110)	10
03310 Socket (EC215, EC210)	10
DIN 24° DKO Light (DKO-L)	11
10411 Male Rigid	11
20411 Female Swivel	12
20441 Female 45° Elbow	13
20491 Female 90° Elbow	14
DIN 24° DKO Heavy (DKO-S)	15
10511 Male Rigid	15
20511 Female Swivel	16
20541 Female 45° Elbow	17
20591 Female 90° Elbow	18
Code 61 Flange	19
87311 Straight	19
87341 45° Elbow	20
87391 90° Elbow	20
JIC	21
16711 Male Rigid	21
26711 Female Swivel	23
26741 Female 45° Elbow	24
26791 Female 90° Elbow	25
ORS	26
14211 Male Rigid	26
24211 Female Swivel	26
24241 Female 45° Elbow	28
24291 Female 90° Elbow	28
BSP 60° Cone	29
12611A Male Rigid Parallel	29
22611 Female Swivel	30
22641 Female 45° Elbow	31
22691 Female 90° Elbow	31
15611 NPTF Male Rigid	32

1T/4S/6S SPIRAL FITTING SERIES**DIN 24° DKO Light (DKO-L)**

DK Male Rigid	33
DL Female Swivel	33

DIN 24° DKO Heavy (DKO-S)

EK Male Rigid	34
DS Female Swivel	34
DSA Female 45° Elbow	35
DSB Female 90° Elbow	35

Code 61 Flange

FL Straight	36
FLA 45° Elbow	36
FLB 90° Elbow	37

Code 62 Flange

FH Straight	38
FHA 45° Elbow	39
FHB 90° Elbow	40

CAT Flange

CT Straight	41
CTA 45° Elbow	41
CTB 90° Elbow	42

JIC

FJ Female Swivel	43
FJA Female 45° Elbow	44
FJB Female 90° Elbow	44

ORS

FR Female Swivel	45
FRA Female 45° Elbow	45
FRB Female 90° Elbow	46

BSP 60° Cone

BP Male Rigid Parallel	47
BF Female Swivel	47
BFA Female 45° Elbow	48
BFB Female 90° Elbow	48

Important safety and ordering information

WARNING

Eaton fitting tolerances are engineered to match approved Eaton hose tolerances. The use of Eaton fittings on hose supplied by other manufacturers and/or the use of Eaton hoses with fittings supplied by other manufacturers may result in the production of unreliable and unsafe hose assemblies and is neither recommended nor authorized by Eaton or any of its affiliates or subsidiaries.

WARNING

Application considerations must be observed in selecting appropriate components for the application of these products contained herein. The failure to follow the recommendations set forth in this catalog may result in an unstable application which may result in serious personal injury or property damage.

EATON OR ANY OF ITS AFFILIATES OR SUBSIDIARIES SHALL NOT BE SUBJECT TO AND DISCLAIMS ANY OBLIGATIONS OR LIABILITIES (INCLUDING BUT NOT LIMITED TO ALL CONSEQUENTIAL, INCIDENTAL AND CONTINGENT DAMAGES) ARISING FROM TORT CLAIMS (INCLUDING WITHOUT LIMITATION NEGLIGENCE AND STRICT LIABILITY) OR OTHER THEORIES OF LAW WITH RESPECT TO ANY HOSE ASSEMBLIES NOT PRODUCED FROM GENUINE EATON HOSE FITTINGS, HOSE AND EATON APPROVED EQUIPMENT, AND IN CONFORMANCE WITH EATON'S SYNPLEX PROCESS AND PRODUCT INSTRUCTIONS FOR EACH SPECIFIC HOSE ASSEMBLY.

Failure to follow these processes and product instructions and limitations could lead to premature hose assembly failures resulting in property damage, serious injury or death.

Warranty

Current warranty information can be found at: www.eaton.com/hydraulics/warranty

Hose Fitting Part Number Nomenclature

26711 D-04-04 SM W ZF

Fitting Series

Material Stock Code

A = Large hex stock

D = Hex stock female nipple

If material is round stock position collapses

Terminal End Size

Hose Size

Special Suffix Code

SM = Backup hex smaller than swivel hex

SP = BSPT with 60° cone

If no special design is required, position collapses

Nut Design

T = Captive nut

W = Wire nut

If crimp nut is used or if nut is not required, position collapses

Plating Type Code

ZF = Zinc Trivalent Chromate (Cr3)

Hose Installation

Proper installation of the hose is essential to the proper operation and safe use of the hose and related equipment. Improper installation of the hose can result in serious injury or property damage caused by spraying fluids or flying projectiles. In order to avoid serious bodily injury or property damage resulting from improper installation of the hose, you should carefully review the information in this catalog regarding hose installation.

Some of the factors you must consider in installing the hose properly are:

- Changes in length
- Proper bend radius
- Protection from high temperature sources
- Elbows and adapters to relieve strain
- Rubbing or abrasion
- Twisting
- Improper hose movement

These factors and the other information in this catalog regarding hose installation should be considered by you before installing the hose. If you have any questions regarding proper hose installation, please contact Eaton Technical Support.

Hose Maintenance

Proper maintenance of the hose is essential to the safe use of the hose and related equipment. Hose should be stored in a dry place. Hose should also be visually inspected. Any hose that has a cut or gouge in the cover that exposes the reinforcement should be retired from service. Hoses should also be inspected for kinking or broken reinforcement. If the outside diameter of the hose is reduced by 20% at the spot where it is bent then the hose should be retired from service. Inadequate attention to maintenance of the hose can result in hose leakage, bursting, or other failure which can cause serious bodily injury or property damage from spraying fluids, flying projectiles, or other substances.

Eaton Winner Hose Fittings

Braided Hose Fittings

Spiral Hose Fittings

Premium TTC/Z-Series



Features:

- New **DURA-KOTE™** plating technology for up to 1,000 hours of corrosion resistance
- Bite the wire technology for best in class connection and sealing
- Class zero leakage SAE J1176 on approved hose styles
- Over 550 TTC Series part numbers available
- Eaton's **MatchMate™** program provides identification markings on the hose, hose fittings, and crimp dies for quick and easy assembly

Refer to master catalog for more information.

Standard Two-piece Winner



Features:

- Non-skive, two-piece crimp fitting
- One nipple part number for EC115, EC215 standard hoses
- Meets industry specifications when used with the EC115, EC215 standard hoses
- Clear silver hexavalent chromium-free plating
- Carbon steel material

Premium 4S/6S Spiral Series



Features:

- New **DURA-KOTE™** plating technology for up to 1,000 hours of corrosion resistance
- New patent pending **DURA-SEAL™** technology to eliminate hose assembly cool-down leakage
- Class zero leakage SAE J1176 on approved hose styles
- Eaton's **MatchMate™** spiral-hose/fitting identification system program provides identification markings on the hose, hose fittings, and crimp dies for quick and easy assembly

Refer to master catalog for more information.

DURA-KOTE™ Plating Technology

Hose fittings that will now offer 3x the corrosion protection on carbon steel fittings as compared to competitive hose fittings. Eaton's DURA-KOTE fittings provide up to 1000 hours of corrosion protection. This is a huge step forward in metal fitting corrosion protection. (Only on 4S/6S fittings)

3X Carbon Steel Corrosion Protection



DURA-SEAL™ Technology

This patent-pending innovation from Eaton eliminates hose assembly cool-down leakage, while extending hose assembly life, reducing equipment down-time. (Only on 4S/6S fittings)

Class 0 Cool-Down Leakage Protection



EC115 Hydraulic Hose

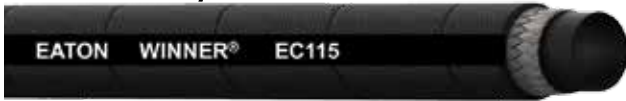

Meets EN 857 Type 1SC

# Part number	Hose I.D.		Hose O.D. (max)		Working Pressure		Min. Burst Pressure		Min. Bend Radius		Weight	
	mm	in	mm	in	bar	psi	bar	psi	mm	in	kg/m	lbs/ft
EC115-04L	6.4	0.25	13.5	0.53	225	3,250	900	13,000	50	1.97	0.18	0.12
EC115-05L	7.9	0.31	14.5	0.57	215	3,125	860	12,500	55	2.17	0.20	0.13
EC115-06L	9.5	0.38	16.9	0.67	180	2,600	720	10,400	63	2.48	0.26	0.17
EC115-08L	12.7	0.50	20.4	0.80	160	2,300	640	9,200	90	3.54	0.34	0.23
EC115-10L	15.9	0.62	23.0	0.91	130	1,900	520	7,600	100	3.94	0.42	0.28
EC115-12L	19.0	0.75	26.7	1.05	105	1,525	420	6,100	120	4.72	0.50	0.34
EC115-16L	25.4	1.00	34.9	1.37	88	1,275	352	5,100	160	6.30	0.74	0.50
EC115-20L	31.8	1.25	42.4	1.67	63	925	252	3,700	210	8.27	0.99	0.67
EC115-24L	38.1	1.50	49.0	1.93	50	725	200	2,900	300	11.81	1.20	0.81
EC115-32L	50.8	2.00	62.0	2.44	40	580	160	2,320	400	15.75	1.50	1.01

Operating Temperature :

-40°C to +100°C (-40°F to +212°F)

Fittings:



TTC Series



Two-piece Winner

Inner Tube:

Synthetic rubber tube

Reinforcement:

One steel braid

Cover:

Synthetic rubber cover

Typical Application:

Hydraulic system service with petroleum and water based fluids, for general industrial service.

MSHA Approved

DNVGL Approved

EC215 Hydraulic Hose



Meets EN 857 Type 2SC

# Part number	Hose I.D.		Hose O.D. (max)		Working Pressure		Min. Burst Pressure		Min. Bend Radius		Weight	
	mm	in	mm	in	bar	psi	bar	psi	mm	in	kg/m	lbs/ft
EC215-04L	6.4	0.25	14.2	0.56	400	5,800	1,600	23,200	50	1.97	0.28	0.19
EC215-05L	7.9	0.31	16.0	0.63	350	5,100	1,400	20,400	55	2.17	0.33	0.22
EC215-06L	9.5	0.38	18.3	0.72	345	5,000	1,380	20,000	65	2.56	0.41	0.28
EC215-08L	12.7	0.50	21.5	0.85	275	4,000	1,100	16,000	90	3.54	0.57	0.38
EC215-10L	15.9	0.62	24.7	0.97	250	3,650	1,000	14,600	100	3.94	0.68	0.46
EC215-12L	19.0	0.75	28.6	1.13	215	3,125	860	12,500	120	4.72	0.81	0.54
EC215-16L	25.4	1.00	36.6	1.44	165	2,400	660	9,600	160	6.30	1.17	0.79
EC215-20L	31.8	1.25	45.1	1.78	125	1,800	500	7,200	250	9.84	1.56	1.05
EC215-24L	38.1	1.50	52.3	2.06	100	1,450	400	5,800	300	11.81	1.81	1.22
EC215-32L	50.8	2.00	64.2	2.53	90	1,300	360	5,200	400	15.75	2.36	1.59

Operating Temperature :

-40°C to +100°C (-40°F to +212°F)

Fittings:



TTC Series



Two-piece Winner

Inner Tube:

Synthetic rubber tube

Reinforcement:

Two steel braids

Cover:

Synthetic rubber cover

Typical Application:

Hydraulic system service with petroleum and water based fluids, for general industrial service.

MSHA Approved

DNVGL Approved

EC110 Hydraulic Hose



Meets EN 853 1 SN

# Part number	Hose I.D.		Hose O.D. (max)		Working Pressure		Min. Burst Pressure		Min. Bend Radius		Weight	
	mm	in	mm	in	bar	psi	bar	psi	mm	in	kg/m	lbs/ft
EC110-04L	6.4	0.25	14.1	0.56	225	3,250	900	13,000	100	3.94	0.22	0.15
EC110-05L	7.9	0.31	15.7	0.62	215	3,125	860	12,500	115	4.53	0.26	0.17
EC110-06L	9.5	0.38	18.1	0.71	180	2,600	720	10,400	130	5.12	0.33	0.22
EC110-08L	12.7	0.50	21.4	0.84	160	2,300	640	9,200	180	7.09	0.41	0.28
EC110-10L	15.9	0.62	24.5	0.96	130	1,900	520	7,600	200	7.87	0.47	0.32
EC110-12L	19.0	0.75	28.5	1.12	105	1,525	420	6,100	240	9.45	0.59	0.40
EC110-16L	25.4	1.00	36.6	1.44	88	1,275	352	5,100	300	11.81	0.87	0.58
EC110-20L	31.8	1.25	44.8	1.76	63	925	252	3,700	420	16.54	1.20	0.81
EC110-24L	38.1	1.50	52.1	2.05	50	725	200	2,900	500	19.69	1.40	0.94
EC110-32L	50.8	2.00	65.5	2.58	40	580	160	2,320	630	24.80	1.91	1.28
EC110-40L	63.5	2.50	78.0	3.07	40	580	200	2,900	762	30.00	2.52	1.69
EC110-48L	76.2	3.00	90.5	3.56	35	508	160	2,320	900	35.43	2.70	1.81

Operating Temperature :

-40°C to +100°C (-40°F to +212°F)

Fittings:



TTC Series



Two-piece Winner

Inner Tube:

Synthetic rubber tube

Reinforcement:

One steel braid

Cover:

Synthetic rubber cover

Typical Application:

Hydraulic system service with petroleum and water based fluids, for general industrial service.

MSHA Approved

DNVGL Approved

EC210 Hydraulic Hose



Meets EN 853 2 SN

# Part number	Hose I.D.		Hose O.D. (max)		Working Pressure		Min. Burst Pressure		Min. Bend Radius		Weight	
	mm	in	mm	in	bar	psi	bar	psi	mm	in	kg/m	lbs/ft
EC210-04L	6.4	0.25	15.7	0.62	400	5,800	1,600	23,200	100	3.94	0.38	0.26
EC210-05L	7.9	0.31	17.3	0.68	350	5,100	1,400	20,400	115	4.53	0.43	0.29
EC210-06L	9.5	0.38	19.7	0.78	330	4,800	1,320	19,200	130	5.12	0.54	0.36
EC210-08L	12.7	0.50	23.0	0.91	275	4,000	1,100	16,000	180	7.09	0.64	0.43
EC210-10L	15.9	0.62	26.2	1.03	250	3,650	1,000	14,600	200	7.87	0.75	0.50
EC210-12L	19.0	0.75	30.1	1.19	215	3,125	860	12,500	240	9.45	0.93	0.62
EC210-16L	25.4	1.00	38.9	1.53	165	2,400	660	9,600	300	11.81	1.29	0.87
EC210-20L	31.8	1.25	49.5	1.95	125	1,800	500	7,200	420	16.54	1.89	1.27
EC210-24L	38.1	1.50	55.9	2.20	90	1,300	360	5,200	500	19.69	2.10	1.41
EC210-32L	50.8	2.00	68.6	2.70	80	1,150	320	4,600	630	24.80	2.76	1.85
EC210-40L	63.5	2.50	81.0	3.19	69	1,000	300	4,350	760	29.92	3.80	2.55
EC210-48L	76.2	3.00	93.0	3.66	50	725	240	3,500	900	35.43	4.03	2.71

Operating Temperature :

-40°C to +100°C (-40°F to +212°F)

Fittings:



TTC Series



Two-piece Winner

Inner Tube:

Synthetic rubber tube

Reinforcement:

Two steel braids

Cover:

Synthetic rubber cover

Typical Application:

Hydraulic system service with petroleum and water based fluids, for general industrial service.

MSHA Approved

DNVGL Approved

EC426 Hydraulic Hose



Meets EN856 4SP

# Part number	Hose I.D.			Hose O.D. (maximum)		Max operating pressure		Minimum burst pressure		Minimum bend radius		Weight	
	DN	mm	in	mm	in	bar	psi	bar	psi	mm	in	Kg/m	lbs/ft
EC426-6	10	9.5	0.37	20.9	0.82	445	6450	1780	25800	180	7.09	0.74	0.50
EC426-8	12	12.7	0.50	25.4	1.00	415	6000	1660	24000	230	9.06	0.88	0.59
EC426-10	16	15.9	0.62	29.0	1.14	350	5100	1400	20400	250	9.84	1.04	0.70
EC426-12	19	19.0	0.75	33.0	1.30	350	5100	1400	20400	300	11.81	1.47	0.99
EC426-16	25	25.4	1.00	40.9	1.61	280	4050	1120	16200	340	13.39	1.90	1.28
EC426-20	31	31.8	1.25	48.6	1.91	210	3050	840	12200	460	18.11	2.46	1.65

Operating Temperature :

-40°C to +100°C (-40°F to +212°F)

Fittings:



1T series (-6,-8,-10)
4S/6S series (-12,-16)

Inner Tube:

Synthetic rubber tube

Reinforcement:

Four wire spiral

Cover:

Synthetic rubber cover

Typical Application:

Hydraulic systems service with petroleum and water based fluids, for general use.

MSHA Approved

EC512 Hydraulic Hose

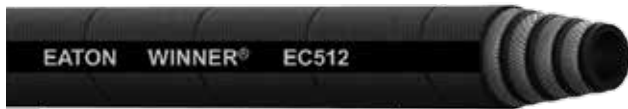

Meets EN856 4SH

# Part number	Hose I.D.			Hose O.D. (maximum)		Max operating pressure		Minimum burst pressure		Minimum bend radius		Weight	
	DN	mm	in	mm	in	bar	psi	bar	psi	mm	in	Kg/m	lbs/ft
EC512-12	19	19	0.75	33.0	1.30	420	6100	1680	24400	280	11.02	1.47	0.99
EC512-16	25	25.4	1.00	39.9	1.57	380	5500	1520	22000	340	13.39	2.04	1.37
EC512-20	31	31.8	1.25	47.1	1.85	350	5100	1400	20400	460	18.11	2.39	1.61
EC512-24	38	38.1	1.05	55.1	2.17	290	4200	1160	16800	560	22.05	3.19	2.14
EC512-32	51	50.8	2.00	69.7	2.74	250	3650	1000	14600	700	27.56	4.37	2.94

Operating Temperature :

-40°C to +100°C (-40°F to +212°F)

Fittings:



4S/6S Series

Inner Tube:

Synthetic rubber tube

Reinforcement:

Four wire spiral

Cover:

Synthetic rubber cover

Typical Application:







Hydraulic systems service with petroleum and water based fluids, for general use.

MSHA Approved

EC420 Hydraulic Hose



Meets SAE 100R13

#												
	Part number	Hose I.D.		Hose O.D. (maximum)		Max operating pressure		Minimum burst Pressure		Minimum bend radius		Weight
	mm	in	mm	in	bar	psi	bar	psi	mm	in	Kg/m	lbs/ft
EC420-12	19.0	0.75	33.2	1.31	350	5,100	1,400	20,400	240	9.45	1.54	1.03
EC420-16	25.4	1.00	39.9	1.57	350	5,100	1,400	20,400	300	11.81	2.01	1.35
EC420-20	31.8	1.25	51.3	2.02	350	5,100	1,400	20,400	420	16.54	3.78	2.54
EC420-24	38.1	1.50	58.8	2.31	350	5,100	1,400	20,400	500	19.69	4.73	3.18
EC420-32	50.8	2.00	72.7	2.86	350	5,100	1,400	20,400	630	24.80	7.26	4.88

Operating Temperature :

For -12, -20, -24, & -32: -40°C to +121°C (-40°F to +250°F)

For -16: -40°C to +100°C (-40°F to +212°F)

Fittings:



4S/6S Series

Inner Tube:

Synthetic rubber tube

Reinforcement:

Four & six wire spiral reinforcement

Cover:

Synthetic rubber cover

Typical Application:







Suitable for use in hydraulic systems with high peak pressures and arduous operating conditions.

MSHA Approved

EC615 Hydraulic Hose



SAE 100R15 Performance

#												
	Part number	Hose I.D.		Hose O.D. (maximum)		Max operating pressure		Minimum burst pressure		Minimum bend radius		Weight
	mm	in	mm	in	bar	psi	bar	psi	mm	in	Kg/m	lbs/ft
EC615-16	25.4	1.00	39.9	1.57	420	6,100	1,680	24,400	330	12.99	2.00	1.35
EC615-20	31.8	1.25	51.3	2.02	420	6,100	1,680	24,400	445	17.52	3.77	2.53
EC615-24	38.1	1.50	58.8	2.31	420	6,100	1,680	24,400	530	20.87	5.17	3.47
EC615-32	50.8	2.00	72.8	2.87	420	6,100	1,680	24,400	600	23.62	7.26	4.88

Operating Temperature :

-40°C to +100°C (-40°F to +212°F)

Fittings:



4S/6S Series

Inner Tube:

Synthetic rubber tube

Reinforcement:

Four & six wire spiral reinforcement

Cover:

Synthetic rubber cover

Typical Application:

Suitable for use in hydraulic and oil systems.

MSHA Approved

Eaton Winner Two-piece Braided Hose Fittings

For use with hose: EC115, EC215, EC110, EC210

EC110-EC115 Socket

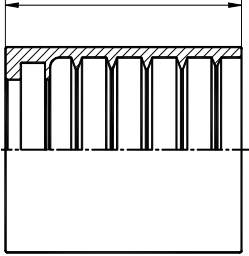

# Part Number	Hose Size		Dimension L		OD		Weight	
	DN	Dash Size	mm	in	mm	in	kg	lb
00110-04AEWZ	6	-04	27,5	1.08	21,0	0.83	0,03	0.07
00110-05AEWZ	8	-05	28,0	1.10	21,5	0.85	0,03	0.06
00110-06AEWZ	10	-06	30,0	1.18	24,3	0.96	0,04	0.08
00110-08AEWZ	12	-08	34,0	1.34	28,0	1.10	0,05	0.10
00110-10AEWZ	16	-10	37,0	1.46	31,3	1.23	0,06	0.13
00110-12AEWZ	20	-12	42,0	1.65	28,7	1.13	0,08	0.17
00110-16AEWZ	25	-16	51,0	2.01	43,5	1.71	0,13	0.28
00110-20EWZ	32	-20	59,0	2.32	52,0	2.05	0,21	0.46
00110-24EWZ	40	-24	74,0	2.91	58,0	2.28	0,27	0.58
00110-32EWZ	50	-32	78,0	3.07	72,0	2.83	0,39	0.86

EC210-EC215 Socket

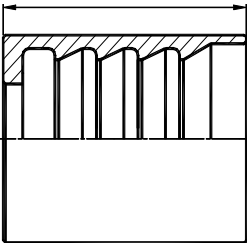



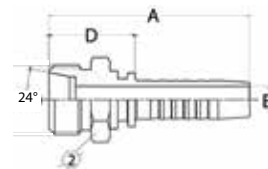

# Part Number	Hose Size		Dimension L		OD		Weight	
	DN	Dash Size	mm	in	mm	in	kg	lb
03310-04EWZ	6	-04	30,5	1.20	23,0	0.91	0,04	0.09
03310-05EWZ	8	-05	30,0	1.18	24,0	0.94	0,04	0.08
03310-06EWZ	10	-06	32,0	1.26	26,0	1.02	0,04	0.09
03310-08EWZ	12	-08	34,0	1.34	29,0	1.14	0,05	0.10
03310-10AEWZ	16	-10	35,0	1.38	34,5	1.36	0,06	0.14
03310-12EWZ	20	-12	42,0	1.65	37,0	1.46	0,08	0.18
03310-16EWZ	25	-16	52,0	2.05	46,7	1.84	0,15	0.33
03310-20AEWZ	32	-20	59,0	2.32	59,0	2.32	0,26	0.57
03310-24AEWZ	40	-24	67,0	2.64	67,0	2.64	0,43	0.94
03310-32AEWZ	50	-32	72,0	2.83	80,0	3.15	0,61	1.34

Eaton Winner 2 piece braided hose fitting

DIN 24° Male Rigid
(DKO Light)





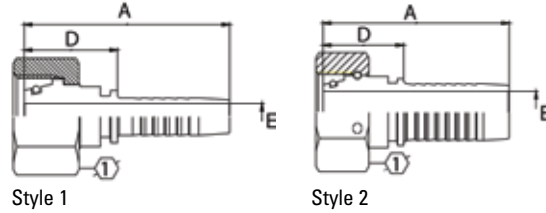

# Part Number	Terminal End	 Thread	 Hose Size		A		D Cut Off Factor		E Ø				 Weight	
			DN	Dash Size	mm	in	mm	in	mm	in			mm	mm
10411-12-04Z	-12	M12x1.5	6	-04	48,5	1.91	20,5	0.81	4,0	0.16	--	12	0,015	0.033
10411-14-04Z	-14	M14x1.5	6	-04	48,5	1.91	20,5	0.81	4,0	0.16	--	14	0,020	0.044
10411-14-05Z	-14	M14x1.5	8	-05	49,5	1.95	21,5	0.85	5,5	0.22	--	14	0,020	0.044
10411-16-04Z	-16	M16x1.5	6	-04	50,5	1.99	22,5	0.89	4,0	0.16	--	17	0,025	0.055
10411-16-05Z	-16	M16x1.5	8	-05	50,5	1.99	22,5	0.89	5,5	0.22	--	17	0,025	0.055
10411-16-06Z	-16	M16x1.5	10	-06	52,5	2.07	22,5	0.89	7,0	0.28	--	17	0,034	0.075
10411-18-04Z	-18	M18x1.5	6	-04	51,5	2.03	23,5	0.93	4,0	0.16	--	19	0,030	0.066
10411-18-05Z	-18	M18x1.5	8	-05	51,5	2.03	23,5	0.93	5,5	0.22	--	19	0,030	0.066
10411-18-06Z	-18	M18x1.5	10	-06	52,5	2.07	22,5	0.89	7,0	0.28	--	19	0,035	0.077
10411-18-08Z	-18	M18x1.5	12	-08	55,5	2.19	24,0	0.95	10,0	0.39	--	19	0,045	0.099
10411-22-06Z	-22	M22x1.5	10	-06	54,5	2.15	24,5	0.96	7,0	0.28	--	24	0,050	0.110
10411-22-08Z	-22	M22x1.5	12	-08	57,5	2.26	26,0	1.02	10,0	0.39	--	24	0,060	0.132
10411-26-08Z	-26	M26x1.5	12	-08	58,0	2.28	26,5	1.04	10,0	0.39	--	27	0,076	0.167
10411-26-10Z	-26	M26x1.5	16	-10	60,5	2.38	26,5	1.04	12,0	0.47	--	27	0,080	0.176
10411-30-12Z	-30	M30x2	20	-12	68,5	2.70	30,0	1.18	15,0	0.59	--	32	0,122	0.268
10411-36-12Z	-36	M36x2	20	-12	69,5	2.75	31,0	1.22	15,0	0.59	--	38	0,164	0.361
10411-36-16Z	-36	M36x2	25	-16	78,5	3.09	31,5	1.24	21,0	0.83	--	38	0,178	0.392
10411-45-20Z	-45	M45x2	32	-20	91,0	3.58	37,0	1.46	27,0	1.06	--	46	0,310	0.682
10411-52-24Z	-52	M52x2	40	-24	106,0	4.17	38,0	1.50	32,0	1.26	--	55	0,460	1.012

Eaton Winner 2 piece braided hose fitting

DIN 24° Female Swivel
(DKO Light)



# Part Number	Terminal End	 Thread	 Hose Size		A		D Cut Off Factor		E Ø				 Weight	
			DN	Dash Size	mm	in	mm	in	mm	in			mm	mm
20411-12-04WZ**	-12	M12X1.5	6	-04	50,0	1.97	22,5	0.89	4,0	0.16	17	--	0,032	0.071
20411-14-04WZ**	-14	M14X1.5	6	-04	50,5	1.99	22,5	0.89	4,0	0.16	17	--	0,030	0.066
20411-14-05WZ**	-14	M14X1.5	8	-05	50,5	1.99	22,5	0.89	5,5	0.22	17	--	0,032	0.071
20411-14-06WZ**	-14	M14X1.5	10	-06	53,0	2.09	23,0	0.91	7,0	0.28	17	--	0,035	0.077
20411-16-04TZ*	-16	M16X1.5	6	-04	48,5	1.91	20,5	0.81	4,0	0.16	19	--	0,032	0.071
20411-16-05WZ**	-16	M16X1.5	8	-05	50,0	1.97	22,0	0.87	5,5	0.22	19	--	0,038	0.084
20411-16-06WZ**	-16	M16X1.5	10	-06	53,5	2.11	23,5	0.93	7,0	0.28	19	--	0,044	0.097
20411-18-04TZ*	-18	M18X1.5	6	-04	52,5	2.07	24,5	0.96	4,0	0.16	22	--	0,047	0.104
20411-18-05TZ*	-18	M18X1.5	8	-05	52,5	2.07	24,5	0.96	5,5	0.22	22	--	0,055	0.121
20411-18-06TZ*	-18	M18X1.5	10	-06	57,5	2.26	27,5	1.08	7,0	0.28	22	--	0,055	0.121
20411-18-08WZ**	-18	M18X1.5	12	-08	56,0	2.2	24,5	0.96	10,0	0.39	22	--	0,064	0.141
20411-22-10WZ**	-22	M22X1.5	16	-10	60,0	2.36	26,0	1.02	12,0	0.47	27	--	0,105	0.231
20411-22-04TZ*	-22	M22X1.5	6	-04	54,5	2.15	26,5	1.04	4,0	0.16	27	--	0,075	0.165
20411-22-05TZ*	-22	M22X1.5	8	-05	54,5	2.15	26,5	1.04	5,5	0.22	27	--	0,078	0.172
20411-22-06TZ*	-22	M22X1.5	10	-06	56,5	2.22	26,5	1.04	7,0	0.28	27	--	0,084	0.185
20411-22-08TZ*	-22	M22X1.5	12	-08	60,5	2.38	29,0	1.14	10,0	0.39	27	--	0,076	0.168
20411-26-10TZ*	-26	M26X1.5	16	-10	64,0	2.52	30,0	1.18	12,0	0.47	32	--	0,120	0.265
20411-26-12WZ**	-26	M26X1.5	20	-12	67,0	2.64	27,5	1.08	15,0	0.59	32	--	0,145	0.32
20411-26-08TZ*	-26	M26X1.5	12	-08	59,0	2.32	27,5	1.08	10,0	0.39	32	--	0,118	0.26
20411-30-10TZ*	-30	M30X2	16	-10	65,0	2.56	31,0	1.22	12,0	0.47	36	--	0,150	0.331
20411-30-12TZ*	-30	M30X2	20	-12	72,5	2.85	34,0	1.34	15,0	0.59	36	--	0,185	0.408
20411-30-16WZ**	-30	M30X2	25	-16	77,5	3.05	30,5	1.2	21,0	0.83	36	--	0,212	0.467
20411-36-12TZ*	-36	M36X2	20	-12	71,5	2.81	33,0	1.3	15,0	0.59	41	--	0,205	0.452
20411-36-16WZ**	-36	M36X2	25	-16	77,0	3.03	30,0	1.18	21,0	0.83	41	--	0,235	0.518
20411-45-16TZ*	-45	M45X2	25	-16	84,0	3.31	37,0	1.46	21,0	0.83	50	--	0,433	0.955
20411-45-20TZ*	-45	M45X2	32	-20	91,5	3.6	37,5	1.48	27,0	1.06	50	--	0,485	1.069
20411-52-20TZ*	-52	M52X2	32	-20	92,5	3.64	38,5	1.52	27,0	1.06	60	--	0,500	1.102
20411-52-24TZ*	-52	M52X2	40	-24	106,5	4.19	38,5	1.52	32,0	1.26	60	--	0,620	1.367





* Denotes Style 1 design

** Denotes Style 2 design

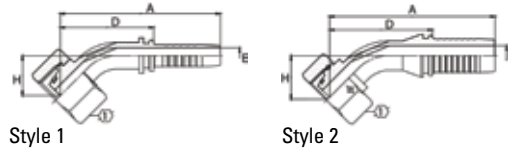
Eaton Winner 2 piece braided hose fitting

DIN 24° Female 45° Elbow
(DKO Light)



# Part Number	Terminal End	 Thread	 Hose Size		A		D Cut Off Factor		E Ø		H				 Weight	
			Dash Size	DN	Dash Size	mm	in	mm	in	mm	in	mm	in	mm	mm	kg
20441-12-04WZ**	-12	M12X1.5	6	-04	6	64,	2.52	36,0	1.42	4,0	0.16	15,1	17	--	0.040	0.088
20441-14-04WZ**	-14	M14X1.5	6	-04	8	66,1	2.60	38,1	1.50	4,0	0.16	16,0	17	--	0.040	0.088
20441-16-04TZ*	-16	M16X1.5	6	-04	10	66,1	2.60	38,1	1.50	4,0	0.16	16,0	19	--	0.050	0.088
20441-16-05WZ**	-16	M16X1.5	8	-05	10	68,3	2.69	40,3	1.59	5,5	0.22	17,0	19	--	0.054	0.119
20441-16-06WZ**	-16	M16X1.5	10	-06	10	70,3	2.77	40,3	1.59	7,0	0.28	17,0	19	--	0.058	0.128
20441-18-05TZ*	-18	M18X1.5	8	-05	12	68,3	2.69	40,3	1.59	5,5	0.22	17,0	22	--	0.070	0.154
20441-18-06TZ*	-18	M18X1.5	10	-06	12	75,	2.95	45,0	1.77	7,0	0.28	18,5	22	--	0.070	0.154
20441-18-08WZ**	-18	M18X1.5	12	-08	12	75,7	2.98	44,2	1.74	10,0	0.39	18,7	22	--	0.086	0.190
20441-22-10WZ**	-22	M22X1.5	16	-10	15	83,	3.27	49,0	1.93	12,0	0.47	22,2	27	--	0.125	0.276
20441-22-06TZ*	-22	M22X1.5	10	-06	15	72,	2.83	42,0	1.65	7,0	0.28	18,0	27	--	0.096	0.212
20441-22-08TZ*	-22	M22X1.5	12	-08	15	80,3	3.16	48,8	1.92	10,0	0.39	20,0	27	--	0.105	0.231
20441-26-10TZ*	-26	M26X1.5	16	-10	18	73,5	2.89	58,0	2.28	12,0	0.47	23,5	32	--	0.178	0.392
20441-26-12WZ**	-26	M26X1.5	20	-12	18	99,9	3.93	61,4	2.42	15,0	0.59	24,6	32	--	0.210	0.463
20441-26-08TZ*	-26	M26X1.5	12	-08	18	78,8	3.10	47,3	1.86	10,0	0.39	21,0	32	--	0.154	0.340
20441-30-10TZ*	-30	M30X2	16	-10	22	90,4	3.56	56,4	2.22	12,0	0.47	24,1	36	--	0.196	0.432
20441-30-12TZ*	-30	M30X2	20	-12	22	101,7	4.00	63,2	2.49	15,0	0.59	25,6	36	--	0.240	0.529
20441-36-12TZ*	-36	M36X2	20	-12	28	100,0	3.94	61,5	2.42	15,0	0.59	25,6	41	--	0.360	0.794
20441-36-16WZ**	-36	M36X2	25	-16	28	124,6	4.91	77,6	3.06	21,0	0.83	32,0	41	--	0.388	0.855
20441-45-16TZ*	-45	M45X2	25	-16	35	124,2	4.90	77,5	3.05	21,0	0.83	32,0	50	--	0.590	1.301
20441-45-20TZ*	-45	M45X2	32	-20	35	145,7	5.62	88,7	3.49	27,0	1.06	38,0	50	--	0.716	1.579
20441-52-20TZ*	-52	M52X2	32	-20	42	144,3	5.68	90,3	3.56	27,0	1.06	38,0	60	--	0.813	1.792
20441-52-24TZ*	-52	M52X2	40	-24	42	185,5	7.19	114,5	4.51	32,0	1.26	43,7	60	--	1.100	2.425

* Denotes Style 1 design
** Denotes Style 2 design

Eaton Winner 2 piece braided hose fitting



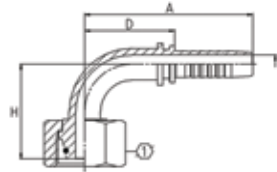

DIN 24° Female 90° Elbow
(DKO Light)

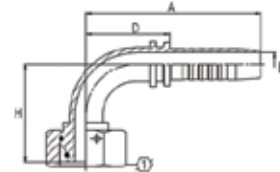

Style 1



Style 2

# Part Number	Terminal End	 Thread	 Hose Size		A		D Cut Off Factor		E Ø		H				 Weight	
			DN	Dash Size	mm	in	mm	in	mm	in	mm	in	mm	mm	kg	lb
20491-12-04VZ**	-12	M12X1.5	6	-04	55,0	2.17	27,0	1.06	4,0	0.16	30,0	1.18	17	--	0,040	0.088
20491-14-04VZ**	-14	M14X1.5	6	-04	58,0	2.28	30,0	1.18	4,0	0.16	30,5	1.20	17	--	0,042	0.093
20491-14-05VZ**	-14	M14X1.5	8	-05	58,0	2.28	30,0	1.18	5,5	0.22	30,5	1.20	17	--	0,046	0.101
20491-14-06VZ**	-14	M14X1.5	10	-06	60,0	2.36	30,0	1.18	7,0	0.28	30,5	1.20	17	--	0,050	0.110
20491-16-04TZ*	-16	M16X1.5	6	-04	58,0	2.28	30,0	1.18	4,0	0.16	30,5	1.20	19	--	0,050	0.110
20491-16-05VZ**	-16	M16X1.5	8	-05	61,0	2.40	33,0	1.30	5,5	0.22	33,0	1.30	19	--	0,070	0.154
20491-16-06VZ**	-16	M16X1.5	10	-06	65,0	2.56	35,0	1.38	7,0	0.28	33,0	1.30	19	--	0,064	0.141
20491-18-04TZ*	-18	M18X1.5	6	-04	58,0	2.28	30,0	1.18	4,0	0.16	30,5	1.20	22	--	0,074	0.163
20491-18-05TZ*	-18	M18X1.5	8	-05	61,0	2.40	33,0	1.30	5,5	0.22	33,5	1.32	22	--	0,077	0.170
20491-18-06TZ*	-18	M18X1.5	10	-06	67,0	2.64	37,0	1.46	7,0	0.28	36,0	1.42	22	--	0,075	0.165
20491-18-08VZ**	-18	M18X1.5	12	-08	70,5	2.78	39,0	1.54	10,0	0.39	37,0	1.46	22	--	0,090	0.198
20491-22-10VZ**	-22	M22X1.5	16	-10	79,0	3.11	45,0	1.77	12,0	0.47	44,5	1.75	27	--	0,145	0.320
20491-22-05TZ*	-22	M22X1.5	8	-05	61,0	2.40	33,0	1.30	5,5	0.22	34,5	1.36	27	--	0,092	0.203
20491-22-06TZ*	-22	M22X1.5	10	-06	64,5	2.54	34,5	1.36	7,0	0.28	36,0	1.42	27	--	0,110	0.243
20491-22-08TZ*	-22	M22X1.5	12	-08	73,5	2.89	42,0	1.65	10,0	0.39	41,5	1.63	27	--	0,126	0.278
20491-26-10TZ*	-26	M26X1.5	16	-10	85,2	3.35	51,2	2.02	12,0	0.47	51,5	2.03	32	--	0,210	0.463
20491-26-12VZ**	-26	M26X1.5	20	-12	94,0	3.70	55,5	2.19	15,0	0.59	51,5	2.03	32	--	0,242	0.534
20491-26-08TZ*	-26	M26X1.5	12	-08	71,0	2.80	39,5	1.56	10,0	0.39	42,9	1.69	32	--	0,160	0.353
20491-30-10TZ*	-30	M30X2	16	-10	83,0	3.27	49,0	1.93	12,0	0.47	51,5	2.03	36	--	0,255	0.562
20491-30-12TZ*	-30	M30X2	20	-12	95,5	3.76	57,0	2.24	15,0	0.59	56,0	2.20	36	--	0,293	0.646
20491-30-16VZ**	-30	M30x2	25	-16	11,25	0.44	65,5	2.58	21,0	0.83	61,5	2.42	36,0	--	0,380	0.838
20491-36-10TZ*	-36	M36X2	16	-10	83,0	3.27	49,0	1.93	12,0	0.47	56,5	2.22	41	--	0,290	0.639
20491-36-12TZ*	-36	M36X2	20	-12	93,8	3.69	55,3	2.18	15,0	0.59	56,0	2.20	41	--	0,422	0.930
20491-36-16VZ**	-36	M36X2	25	-16	118,0	4.65	71,0	2.80	21,0	0.83	68,5	2.70	41	--	0,450	0.992
20491-45-16TZ*	-45	M45X2	25	-16	118,0	4.65	71,0	2.80	21,0	0.83	69,5	2.74	50	--	0,660	1.455
20491-45-24VZ**	-45	M45X2	40	-24	169,5	6.67	101,5	4.00	32,0	1.26	91,5	3.60	50	--	0,900	1.984
20491-45-20TZ*	-45	M45X2	32	-20	135,5	5.33	81,5	3.21	27,0	1.06	78,5	3.09	50	--	0,850	1.874
20491-52-20TZ*	-52	M52X2	32	-20	137,0	5.39	83,0	3.27	27,0	1.06	81,0	3.19	60	--	0,913	2.013
20491-52-24TZ*	-52	M52X2	40	-24	177,5	6.99	109,4	4.31	32,0	1.26	100,5	3.96	60	--	1,470	3.241





* Denotes Style 1 design

** Denotes Style 2 design

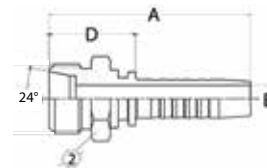
Eaton Winner 2 piece braided hose fitting

DIN 24° Male Rigid
(DKO Heavy)





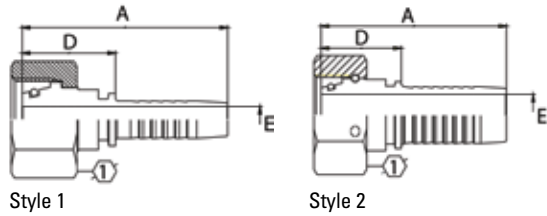

# Part Number	Terminal End	 Thread	 Hose Size		A		D Cut Off Factor		E Ø				 Weight	
					mm	in	mm	in	mm	in			mm	mm
10511-14-04Z	-14	M14x1.5	6	-04	52,5	2.07	24,5	0.96	4,0	0.16	--	14	0,025	0.055
10511-16-04Z	-16	M16x1.5	6	-04	54,5	2.15	26,5	1.04	4,0	0.16	--	17	0,036	0.079
10511-18-04Z	-18	M18x1.5	6	-04	54,5	2.15	26,5	1.04	4,0	0.16	--	19	0,040	0.088
10511-18-06Z	-18	M18x1.5	10	-06	56,5	2.22	26,5	1.04	7,0	0.28	--	19	0,045	0.099
10511-20-05Z	-20	M20x1.5	8	-05	55,0	2.17	27,0	1.06	5,5	0.22	--	22	0,052	0.114
10511-20-06Z	-20	M20x1.5	10	-06	56,5	2.22	26,5	1.04	7,0	0.28	--	22	0,060	0.132
10511-22-06Z	-22	M22x1.5	10	-06	60,5	2.38	30,5	1.20	7,0	0.28	--	24	0,070	0.154
10511-22-08Z	-22	M22x1.5	12	-08	62,5	2.46	31,0	1.22	10,0	0.39	--	24	0,080	0.176
10511-24-08Z	-24	M24x1.5	12	-08	63,0	2.48	31,5	1.24	10,0	0.39	--	27	0,090	0.198
10511-30-10Z	-30	M30x2	16	-10	68,5	2.70	34,5	1.36	12,0	0.47	--	32	0,140	0.308
10511-30-12Z	-30	M30x2	20	-12	74,5	2.93	36,0	1.42	15,0	0.59	--	32	0,150	0.330
10511-36-12Z	-36	M36x2	20	-12	79,0	3.11	40,5	1.59	15,0	0.59	--	41	0,255	0.561
10511-36-16Z	-36	M36x2	25	-16	88,6	3.49	41,5	1.63	21,0	0.83	--	38	0,245	0.539
10511-42-16Z	-42	M42x2	25	-16	91,0	3.58	44,0	1.73	21,0	0.83	--	46	0,336	0.739

Eaton Winner 2 piece braided hose fitting

DIN 24° Female Swivel
(DKO Heavy)



# Part Number	Terminal End	 Thread	 Hose Size		A		D Cut Off Factor		E Ø				 Weight	
			Dash Size	DN	Dash Size	mm	in	mm	in	mm	in	mm	mm	kg
20511-14-04WZ**	-14	M14X1.5	6	-04	51,0	2.01	23,0	0.91	4,0	0.16	17	--	0,030	0.066
20511-16-04TZ*	-16	M16X1.5	6	-04	48,5	1.91	20,5	0.81	4,0	0.16	19	--	0,026	0.057
20511-16-05WZ**	-16	M16X1.5	8	-05	51,0	2.01	23,0	0.91	5,5	0.22	19	--	0,047	0.104
20511-16-06WZ**	-16	M16X1.5	10	-06	53,0	2.09	23,0	0.91	7,0	0.28	19	--	0,045	0.099
20511-18-04TZ*	-18	M18X1.5	6	-04	53,5	2.11	25,5	1.00	4,0	0.16	22	--	0,053	0.117
20511-18-05TZ*	-18	M18X1.5	8	-05	53,5	2.11	25,5	1.00	5,5	0.22	22	--	0,051	0.112
20511-18-06TZ*	-18	M18X1.5	10	-06	56,0	2.20	26,0	1.02	7,0	0.28	22	--	0,054	0.119
20511-20-04TZ*	-20	M20X1.5	6	-04	54,5	2.15	26,5	1.04	4,0	0.16	24	--	0,060	0.132
20511-20-05TZ*	-20	M20X1.5	8	-05	54,5	2.15	26,5	1.04	5,5	0.22	24	--	0,065	0.143
20511-20-06TZ*	-20	M20X1.5	10	-06	56,5	2.22	26,5	1.04	7,0	0.28	24	--	0,065	0.143
20511-20-08WZ**	-20	M20X1.5	12	-08	57,0	2.24	25,5	1.00	10,0	0.39	24	--	0,076	0.168
20511-22-06TZ*	-22	M22X1.5	10	-06	56,5	2.22	26,5	1.04	7,0	0.28	27	--	0,090	0.198
20511-22-08TZ*	-22	M22X1.5	12	-08	59,0	2.32	27,5	1.08	10,0	0.39	27	--	0,088	0.194
20511-24-10WZ**	-24	M24X1.5	16	-10	60,5	2.38	26,5	1.04	12,0	0.47	30	--	0,126	0.278
20511-24-06TZ*	-24	M24X1.5	10	-06	57,0	2.24	27,0	1.06	7,0	0.28	30	--	0,100	0.220
20511-24-08TZ*	-24	M24X1.5	12	-08	59,0	2.32	27,5	1.08	10,0	0.39	30	--	0,106	0.234
20511-30-10TZ*	-30	M30X2	16	-10	67,0	2.64	33,0	1.30	12,0	0.47	36	--	0,180	0.397
20511-30-12TZ*	-30	M30X2	20	-12	73,5	2.89	35,0	1.38	15,0	0.59	36	--	0,195	0.430
20511-30-08TZ*	-30	M30X2	12	-08	64,0	2.52	32,5	1.28	10,0	0.39	36	--	0,170	0.375
20511-36-12TZ*	-36	M36X2	20	-12	73,5	2.89	35,0	1.38	15,0	0.59	46	--	0,300	0.661
20511-36-16WZ**	-36	M36X2	25	-16	78,5	3.09	31,5	1.24	21,0	0.83	46	--	0,330	0.728
20511-42-12TZ*	-42	M42X2	20	-12	76,0	2.99	37,5	1.48	15,0	0.59	50	--	0,362	0.798
20511-42-16TZ*	-42	M42X2	25	-16	85,5	3.37	38,5	1.52	21,0	0.83	50	--	0,370	0.816
20511-42-20WZ**	-42	M42X2	32	-20	85,5	3.37	31,5	1.24	27,0	1.06	50	--	0,404	0.891
20511-52-20TZ*	-52	M52X2	32	-20	95,5	3.76	41,5	1.63	27,0	1.06	60	--	0,626	1.380
20511-52-24TZ*	-52	M52X2	40	-24	109,5	4.31	41,5	1.63	32,0	1.26	60	--	0,700	1.543





* Denotes Style 1 design

** Denotes Style 2 design

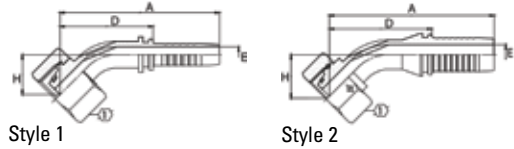
Eaton Winner 2 piece braided hose fitting

DIN 24° Female 45° Elbow
(DKO Heavy)



# Part Number	Terminal End	 Thread	 Hose Size		A		D Cut Off Factor		E Ø		H				 Weight	
					mm	in	mm	in	mm	in	mm	in			mm	mm
20541-16-04TZ*	-16	M16X1.5	6	-04	66,4	2.61	38,4	1.51	4,0	0.16	16,3	0.64	19	--	0,045	0.099
20541-18-04TZ*	-18	M18X1.5	6	-04	67,1	2.64	39,1	1.54	4,0	0.16	17,0	0.67	22	--	0,058	0.128
20541-18-06TZ*	-18	M18X1.5	10	-06	73,8	2.91	43,8	1.72	7,0	0.28	17,3	0.68	22	--	0,062	0.137
20541-20-06TZ*	-20	M20X1.5	10	-06	72,5	2.85	42,5	1.67	7,0	0.28	18,5	0.73	24	--	0,085	0.187
20541-22-08TZ*	-22	M22X1.5	12	-08	81,1	3.19	49,6	1.95	10,0	0.39	20,7	0.81	27	--	0,118	0.260
20541-22-06TZ	-22	M22x1.5	10	-06	72,0	2.84	42,0	1.65	7,0	0.28	18,0	0.71	27	--	0,105	0.231
20541-24-06TZ*	-24	M24X1.5	10	-06	72,3	2.85	42,3	1.67	7,0	0.28	18,4	0.72	30	--	0,114	0.251
20541-24-08TZ*	-24	M24X1.5	12	-08	78,8	3.10	47,3	1.86	10,0	0.39	21,0	0.83	30	--	0,142	0.313
20541-30-10TZ*	-30	M30X2	16	-10	91,3	3.59	57,3	2.26	12,0	0.47	25,0	0.98	36	--	0,250	0.551
20541-30-12TZ*	-30	M30X2	20	-12	104,3	4.11	65,8	2.59	15,0	0.59	26,7	1.05	36	--	0,248	0.547
20541-36-12TZ*	-36	M36X2	20	-12	105,6	4.16	67,1	2.64	15,0	0.59	30,5	1.20	46	--	0,400	0.882
20541-36-16WZ**	-36	M36X2	25	-16	124,4	4.90	77,4	3.05	21,0	0.83	31,2	1.23	46	--	0,450	0.992
20541-42-16TZ*	-42	M42X2	25	-16	128,0	5.04	81,0	3.19	21,0	0.83	35,5	1.40	50	--	0,540	1.190
20541-52-20TZ*	-52	M52X2	32	-20	155,7	6.13	94,2	3.71	27,0	1.06	42,0	1.65	60	--	0,813	1.792
20541-52-24TZ*	-52	M52X2	40	-24	182,1	7.17	114,1	4.49	32,0	1.26	43,4	1.71	60	--	1,284	2.831





* Denotes Style 1 design

** Denotes Style 2 design

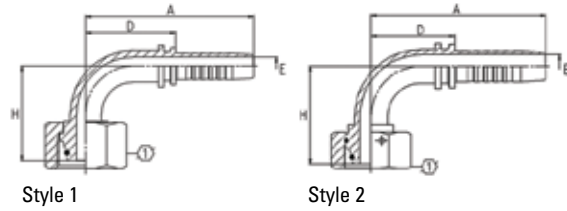
Eaton Winner 2 piece braided hose fitting

DIN 24° Female 90° Elbow (DKO Heavy)



# Part Number	Terminal End	 Thread	 Hose Size		A		D Cut Off Factor		E Ø		H		 1		 2		 Weight	
			Dash Size	DN	Dash Size	mm	in	mm	in	mm	in	mm	in	mm	mm	kg	lb	
20591-14-04VZ**	-14	M14X1.5	6	-04	58,0	2.28	30,0	1.18	4,0	0.16	30,5	1.20	17	--	0,045	0.099		
20591-16-04TZ*	-16	M16X1.5	6	-04	58,0	2.28	30,0	1.18	4,0	0.16	31,0	1.22	19	--	0,040	0.088		
20591-16-05VZ**	-16	M16X1.5	8	-05	58,0	2.28	30,0	1.18	5,5	0.22	31,0	1.22	19	--	0,050	0.110		
20591-16-06VZ**	-16	M16X1.5	10	-06	60,0	2.36	30,0	1.18	7,0	0.28	31,0	1.22	19	--	0,059	0.130		
20591-18-04TZ*	-18	M18X1.5	6	-04	58,0	2.28	30,0	1.18	4,0	0.16	32,0	1.26	22	--	0,065	0.144		
20591-18-05TZ*	-18	M18X1.5	8	-05	61,0	2.40	33,0	1.30	5,5	0.22	33,5	1.32	22	--	0,050	0.110		
20591-18-06TZ*	-18	M18X1.5	10	-06	67,0	2.64	37,0	1.46	7,0	0.28	35,0	1.38	22	--	0,078	0.172		
20591-20-05TZ*	-20	M20X1.5	8	-05	61,0	2.40	33,0	1.30	5,5	0.22	34,0	1.34	24	--	0,080	0.176		
20591-20-06TZ*	-20	M20X1.5	10	-06	64,5	2.54	34,5	1.36	7,0	0.28	35,5	1.40	24	--	0,094	0.207		
20591-20-08VZ**	-20	M20X1.5	12	-08	69,5	2.74	38,0	1.50	10,0	0.39	38,0	1.50	24	--	0,098	0.216		
20591-22-06TZ*	-22	M22X1.5	10	-06	64,5	2.54	34,5	1.36	7,0	0.28	36,0	1.42	27	--	0,114	0.251		
20591-22-08TZ*	-22	M22X1.5	12	-08	73,5	2.89	42,0	1.65	10,0	0.39	42,5	1.67	27	--	0,136	0.300		
20591-24-06TZ*	-24	M24X1.5	10	-06	64,5	2.54	34,5	1.36	7,0	0.28	36,5	1.44	30	--	0,125	0.276		
20591-24-08TZ*	-24	M24X1.5	12	-08	71,0	2.80	39,5	1.56	10,0	0.39	43,0	1.69	30	--	0,136	0.300		
20591-30-08TZ*	-30	M30X2	12	-08	76,0	2.99	44,5	1.75	10,0	0.39	46,0	1.81	36	--	0,196	0.432		
20591-30-10TZ*	-30	M30X2	16	-10	83,0	3.27	49,0	1.93	12,0	0.47	49,5	1.95	36	--	0,265	0.584		
20591-30-12TZ*	-30	M30X2	20	-12	94,3	3.71	55,8	2.20	15,0	0.59	54,5	2.15	36	--	0,265	0.584		
20591-36-12TZ*	-36	M36X2	20	-12	94,5	3.72	56,0	2.20	15,0	0.59	59,0	2.32	46	--	0,482	1.063		
20591-36-16VZ**	-36	M36X2	25	-16	112,5	4.43	65,5	2.58	21,0	0.83	63,5	2.50	46	--	0,500	1.102		
20591-42-16TZ*	-42	M42X2	25	-16	118,0	4.65	71,0	2.80	21,0	0.83	70,0	2.76	50	--	0,610	1.345		
20591-52-20TZ*	-52	M52X2	32	-20	147,0	5.79	93,0	3.66	27,0	1.06	86,5	3.41	60	--	0,945	2.083		
20591-52-24TZ*	-52	M52X2	40	-24	168,0	6.61	100,0	3.94	32,0	1.26	109,4	4.31	60	--	1,630	3.594		



* Denotes Style 1 design

** Denotes Style 2 design

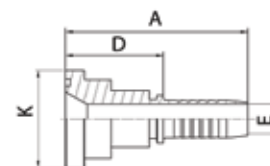
Eaton Winner 2 piece braided hose fitting



Code 61 Flange Straight

# Part Number	Terminal End	K		 Hose Size		A		D Cut Off Factor		E Ø		 Weight	
		Dash Size	mm	in	DN	Dash Size	mm	in	mm	in	mm	in	kg
87311-08-08Z	-08	30.2	1.19	12	-08	77,5	3.05	46,0	1.81	10,0	0.39	0,11	0.24
87311-12-08Z	-12	38,1	1.50	12	-08	78,5	3.09	47,0	1.85	10,0	0.39	0,165	0.364
87311-12-10Z	-12	38.1	1.50	16	-10	81,5	3.21	47,5	1.87	12,0	0.47	0,20	0.44
87311-12-12Z	-12	38.1	1.50	20	-12	86,5	3.41	48,0	1.89	15,0	0.59	0,21	0.46
87311-12-16Z	-12	38.1	1.50	25	-16	96,0	3.78	49,0	1.93	21,0	0.83	0,26	0.58
87311-16-12Z	-16	44.4	1.75	20	-12	89,5	3.52	51,0	2.01	15,0	0.59	0,24	0.52
87311-16-16Z	-16	44.4	1.75	25	-16	99,0	3.90	52,0	2.05	21,0	0.83	0,30	0.65
87311-16-20Z	-16	44.4	1.75	32	-20	107,0	4.21	53,0	2.09	27,0	1.06	0,37	0.81
87311-20-16Z	-20	50.8	2.00	25	-16	104,0	4.09	57,0	2.24	21,0	0.83	0,35	0.78
87311-20-20Z	-20	50.8	2.00	32	-20	112,0	4.41	58,0	2.28	27,0	1.06	0,44	0.97
87311-20-24Z	-20	50.8	2.00	40	-24	129,0	5.08	61,0	2.40	32,0	1.26	0,51	1.11
87311-24-20Z	-24	60.3	2.37	32	-20	122,0	4.80	68,0	2.68	27,0	1.06	0,60	1.32
87311-24-24Z	-24	60.3	2.37	40	-24	136,0	5.35	68,0	2.68	32,0	1.26	0,68	1.50
87311-32-20Z	-32	71.4	2.81	32	-20	124,0	4.88	70,0	2.76	27,0	1.06	0,65	1.43
87311-32-24Z	-32	71.4	2.81	40	-24	138,0	5.43	70,0	2.76	32,0	1.26	0,81	1.78
87311-32-32Z	-32	71.4	2.81	50	-32	142,0	5.59	70,0	2.76	43,0	1.69	1,04	2.29

Eaton Winner 2 piece braided hose fitting

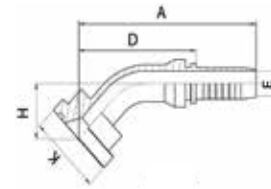

Code 61 Flange 45° Elbow

# Part Number	Terminal End	K		Hose Size		A		D Cut Off Factor		E Ø		H		Weight	
		Dash Size	mm	in	DN	Dash Size	mm	in	mm	in	mm	in	mm	in	kg
87341-08-08Z	-08	30.2	1.19	12	-08	83,4	3.28	58,2	2.29	10,0	0.39	23,3	0.92	0,11	0.24
87341-12-08Z	-12	38,1	1.50	12	-08	90,4	3.56	58,9	2.32	10,0	0.39	24,0	0.94	0,152	0.0335
87341-12-12Z	-12	38.1	1.50	20	-12	108,4	4.27	76,3	3.00	15,0	0.59	28,9	1.14	0,27	0.58
87341-12-16Z	-12	38.1	1.50	25	-16	115,8	4.56	84,7	3.33	21,0	0.83	29,7	1.17	0,33	0.73
87341-16-12Z	-16	44.4	1.75	20	-12	114,7	4.52	76,3	3.00	15,0	0.59	28,9	1.14	0,30	0.65
87341-16-16Z	-16	44.4	1.75	25	-16	121,3	4.78	83,9	3.30	21,0	0.83	29,7	1.17	0,36	0.79
87341-16-20Z	-16	44.4	1.75	32	-20	130,9	5.15	94,5	3.72	27,0	1.06	33,8	1.33	0,47	1.03
87341-20-16Z	-20	50.8	2.00	25	-16	129,0	5.08	85,2	3.35	21,0	0.83	29,7	1.17	0,40	0.87
87341-20-20Z	-20	50.8	2.00	32	-20	137,3	5.41	94,5	3.72	27,0	1.06	33,8	1.33	0,51	1.12
87341-20-24Z	-20	50.8	2.00	38	-24	145,8	5.74	103,0	4.06	32,0	1.26	33,8	1.33	0,66	1.46
87341-24-20Z	-24	60.3	2.37	32	-20	148,2	5.83	95,9	3.78	27,0	1.06	35,2	1.39	0,58	1.28
87341-24-24Z	-24	60.3	2.37	38	-24	162,2	6.39	109,9	4.33	32,0	1.26	39,1	1.54	0,95	2.09
87341-24-32Z	-24	60.3	2.37	50	-32	180,9	7.12	128,6	5.06	43,0	1.69	41,3	1.63	1,22	2.69
87341-32-24Z	-32	71.4	2.81	38	-24	173,3	6.82	109,9	4.33	32,0	1.26	39,1	1.54	1,05	2.31
87341-32-32Z	-32	71.4	2.81	50	-32	192,7	7.59	129,3	5.09	46,0	1.81	46,3	1.82	1,54	3.39

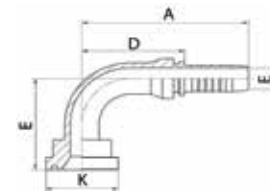



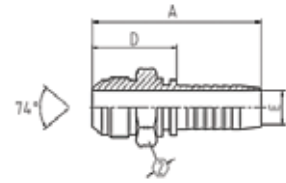

Code 61 Flange 90° Elbow

# Part Number	Terminal End	K		Hose Size		A		D Cut Off Factor		E Ø		H		Weight	
		Dash Size	mm	in	DN	Dash Size	mm	in	mm	in	mm	in	mm	in	kg
87391-08-08Z	-08	30.2	1.19	12	-08	72,5	2.85	41,0	1.61	10,0	0.39	47,0	1.85	0,122	0.268
87391-12-08Z	-12	38,1	1.50	12	-08	72,5	2.85	41,0	1.61	10,0	0.39	48,0	1.89	0,164	0.361
87391-12-10Z	-12	38.1	1.50	16	-10	90,0	3.54	56,0	2.20	12,0	0.47	52,5	2.07	0,220	0.484
87391-12-12Z	-12	38.1	1.50	20	-12	104,7	4.12	66,2	2.61	15,0	0.59	62,0	2.44	0,320	0.704
87391-12-16Z	-12	38.1	1.50	25	-16	123,7	4.87	76,7	3.02	21,0	0.83	67,5	2.66	0,384	0.845
87391-16-12Z	-16	44.4	1.75	20	-12	104,0	4.09	65,5	2.58	15,0	0.59	62,0	2.44	0,370	0.814
87391-16-16Z	-16	44.4	1.75	25	-16	123,7	4.87	76,7	3.02	21,0	0.83	67,5	2.66	0,425	0.935
87391-16-20Z	-16	44.4	1.75	32	-20	145,5	5.73	91,5	3.60	27,0	1.06	78,5	3.09	0,592	1.302
87391-20-12Z	-20	50.8	2.00	20	-12	104,7	4.12	66,2	2.61	15,0	0.59	62,0	2.44	0,388	0.853
87391-20-16Z	-20	50.8	2.00	25	-16	123,7	4.87	76,7	3.02	21,0	0.83	67,5	2.66	0,460	1.012
87391-20-20Z	-20	50.8	2.00	32	-20	145,5	5.73	91,5	3.60	27,0	1.06	78,5	3.09	0,636	1.399
87391-20-24Z	-20	50.8	2.00	40	-24	175,0	6.89	107,0	4.21	32,0	1.26	78,5	3.09	0,902	1.984
87391-24-16Z	-24	60.3	2.37	25	-16	123,7	4.87	76,7	3.02	21,0	0.83	69,5	2.74	0,538	1.184
87391-24-20Z	-24	60.3	2.37	32	-20	145,5	5.73	91,5	3.60	27,0	1.06	80,5	3.17	0,700	1.540
87391-24-24Z	-24	60.3	2.37	40	-24	177,4	6.98	109,4	4.31	32,0	1.26	94,0	3.70	1,212	2.666
87391-32-24Z	-32	71.4	2.81	40	-24	177,4	6.98	109,4	4.31	32,0	1.26	94,0	3.70	1,344	2.957
87391-32-32Z	-32	71.4	2.81	50	-32	203,8	8.02	131,8	5.19	43,0	1.69	114,3	4.50	2,200	4.840

Eaton Winner 2 piece braided hose fitting





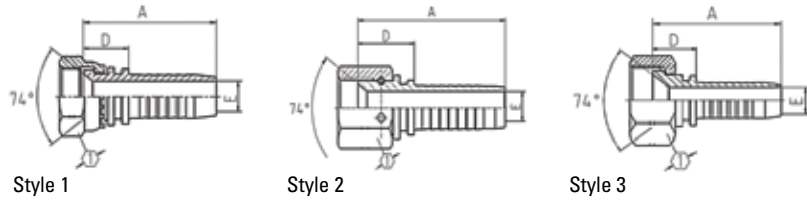

JIC 37° Male Rigid

# Part Number	Terminal End	 Thread	 Hose Size		A		D Cut Off Factor		E Ø				 Weight	
			DN	Dash Size	mm	in	mm	in	mm	in			mm	mm
16711-04-04Z	-04	7/16"-20	6	-04	54,5	2.15	26,5	1.04	4,0	0.16	--	12	0,024	0.053
16711-04-08Z	-04	7/16"-20	12	-08	58,5	2.30	27,0	1.06	10,0	0.39	--	19	0,045	0.099
16711-05-04Z	-05	1/2"-20	6	-04	54,5	2.15	26,5	1.04	4,0	0.16	--	14	0,024	0.053
16711-05-05Z	-05	1/2"-20	8	-05	54,5	2.15	26,5	1.04	5,5	0.22	--	14	0,025	0.055
16711-05-06Z	-05	1/2"-20	10	-06	56,5	2.22	26,5	1.04	7,0	0.28	--	17	0,032	0.071
16711-06-04Z	-06	9/16"-18	6	-04	54,5	2.15	26,5	1.04	4,0	0.16	--	17	0,030	0.066
16711-06-05Z	-06	9/16"-18	8	-05	54,5	2.15	26,5	1.04	5,5	0.22	--	17	0,030	0.066
16711-06-06Z	-06	9/16"-18	10	-06	56,5	2.22	26,5	1.04	7,0	0.28	--	17	0,034	0.075
16711-06-08Z	-06	9/16"-18	12	-08	58,5	2.30	27,0	1.06	10,0	0.39	--	19	0,046	0.101
16711-08-04Z	-08	3/4"-16	6	-04	59,5	2.34	26,7	1.05	4,0	0.16	--	19	0,045	0.099
16711-08-06Z	-08	3/4"-16	10	-06	61,5	2.42	31,5	1.24	7,0	0.28	--	22	0,062	0.137
16711-08-08Z	-08	3/4"-16	12	-08	63,5	2.50	32,0	1.26	9,9	0.39	--	22	0,064	0.141
16711-10-06Z	-10	7/8"-14	10	-06	63,5	2.50	33,5	1.32	7,0	0.28	--	24	0,070	0.154
16711-10-08Z	-10	7/8"-14	12	-08	65,5	2.58	34,0	1.34	10,0	0.39	--	24	0,084	0.185
16711-10-10Z	-10	7/8"-14	16	-10	69,0	2.72	35,0	1.38	12,0	0.47	--	24	0,092	0.203
16711-10-12Z	-10	7/8"-14	20	-12	75,5	2.97	37,0	1.46	15,0	0.59	--	27	0,130	0.287
16711-12-08Z	-12	1.1/16"-12	12	-08	70,0	2.76	38,5	1.52	10,0	0.39	--	30	0,116	0.256
16711-12-10Z	-12	1.1/16"-12	16	-10	73,5	2.89	39,5	1.56	12,0	0.47	--	30	0,120	0.265
16711-12-12Z	-12	1.1/16"-12	20	-12	78,5	3.09	40,0	1.57	15,0	0.59	--	30	0,140	0.309
16711-12-16Z	-12	1.1/16"-12	25	-16	89,5	3.52	42,5	1.67	21,0	0.83	--	32	0,198	0.437
16711-14-12Z	-14	1.3/16"-12	20	-12	79,0	3.11	40,5	1.59	15,0	0.59	--	32	0,162	0.357
16711-16-12Z	-16	1.5/16"-12	20	-12	81,5	3.21	43,0	1.69	15,0	0.59	--	36	0,190	0.419
16711-16-16Z	-16	1.5/16"-12	25	-16	90,5	3.56	43,5	1.71	21,0	0.83	--	36	0,206	0.454
16711-20-16Z	-20	1.5/8"-12	25	-16	94,0	3.70	47,0	1.85	21,0	0.83	--	46	0,336	0.741
16711-20-20Z	-20	1.5/8"-12	32	-20	101,0	3.98	47,0	1.85	27,0	1.06	--	46	0,370	0.816
16711-24-20Z	-24	1.7/8"-12	32	-20	107,0	4.21	53,0	2.09	27,0	1.06	--	50	0,495	1.091
16711-24-24Z	-24	1.7/8"-12	38	-24	121,0	4.76	53,0	2.09	32,0	1.26	--	50	0,542	1.195
16711-32-32Z	-32	2.1/2"-12	50	-32	134,0	5.28	62,0	2.44	43,0	1.69	--	65	1,060	2.337

Eaton Winner 2 piece braided hose fitting



JIC 37° Female Swivel

# Part Number	Terminal End	 Thread	 Hose Size		A		D Cut Off Factor		E Ø				 Weight	
			DN	Dash Size	mm	in	mm	in	mm	in			mm	mm
26711-04-03Z*	-04	7/16"-20	5	-03	35,5	1.40	14,0	0.55	3,0	0.12	14	--	0,015	0.033
26711-04-04Z*	-04	7/16"-20	6	-04	43,0	1.69	15,0	0.59	4,0	0.16	14	--	0,020	0.044
26711-04-05Z*	-04	7/16"-20	8	-05	43,0	1.69	15,0	0.59	5,5	0.22	14	--	0,022	0.049
26711-04-06Z*	-04	7/16"-20	10	-06	44,5	1.75	14,5	0.57	7,0	0.28	14	--	0,028	0.062
26711-05-04Z*	-05	1/2"-20	6	-04	43,5	1.71	15,5	0.61	4,0	0.16	17	--	0,026	0.057
26711-05-05Z*	-05	1/2"-20	8	-05	43,5	1.71	15,5	0.61	5,5	0.22	17	--	0,025	0.055
26711-05-06Z*	-05	1/2"-20	10	-06	45,5	1.79	15,5	0.61	7,0	0.28	17	--	0,032	0.071
26711-06-04Z*	-06	9/16"-18	6	-04	43,5	1.71	15,5	0.61	4,0	0.16	19	--	0,032	0.071
26711-06-05Z*	-06	9/16"-18	8	-05	43,5	1.71	15,5	0.61	5,5	0.22	19	--	0,035	0.077
26711-06-06Z*	-06	9/16"-18	10	-06	45,5	1.79	15,5	0.61	7,0	0.28	19	--	0,037	0.082
26711-06-08Z*	-06	9/16"-18	12	-08	47,5	1.87	16,0	0.63	10,0	0.39	19	--	0,046	0.101
26711-08-04TZ***	-08	3/4"-16	6	-04	43,5	1.71	15,5	0.61	4,0	0.16	24	--	0,054	0.119
26711-08-06Z*	-08	3/4"-16	10	-06	47,5	1.87	17,5	0.69	7,0	0.28	22	--	0,054	0.119
26711-08-08Z*	-08	3/4"-16	12	-08	50,0	1.97	18,5	0.73	9,9	0.39	22	--	0,060	0.132
26711-08-10Z*	-08	3/4"-16	16	-10	52,0	2.05	18,0	0.71	12,0	0.47	22	--	0,078	0.172
26711-08-12Z*	-08	3/4"-16	20	-12	58,0	2.28	19,5	0.77	15,0	0.59	22	--	0,078	0.172
26711-10-06TZ***	-10	7/8"-14	10	-06	47,5	1.87	17,5	0.69	7,0	0.28	27	--	0,080	0.176
26711-10-08Z*	-10	7/8"-14	12	-08	50,5	1.99	19,0	0.75	10,0	0.39	27	--	0,090	0.198
26711-10-10Z*	-10	7/8"-14	16	-10	53,5	2.11	19,5	0.77	12,0	0.47	27	--	0,100	0.220
26711-10-12Z*	-10	7/8"-14	20	-12	58,5	2.30	20,0	0.79	15,0	0.59	27	--	0,110	0.243
26711-12-08TZ***	-12	1.1/16"-12	12	-08	51,0	2.01	19,5	0.77	10,0	0.39	32	--	0,128	0.282
26711-12-10Z*	-12	1.1/16"-12	16	-10	55,0	2.17	21,0	0.83	12,0	0.47	32	--	0,120	0.265
26711-12-12Z*	-12	1.1/16"-12	20	-12	60,0	2.36	21,5	0.85	15,0	0.59	32	--	0,130	0.287
26711-12-16Z*	-12	1.1/16"-12	25	-16	70,0	2.76	23,0	0.91	21,0	0.83	32	--	0,172	0.379
26711-14-12Z*	-14	1.3/16"-12	20	-12	60,0	2.36	21,5	0.85	15,0	0.59	36	--	0,154	0.340
26711-14-16Z*	-14	1.3/16"-12	25	-16	69,5	2.74	22,5	0.89	21,0	0.83	36	--	0,170	0.375
26711-16-12TZ***	-16	1.5/16"-12	20	-12	57,0	2.24	18,5	0.73	15,0	0.59	41	--	0,215	0.474
26711-16-16Z*	-16	1.5/16"-12	25	-16	70,0	2.76	23,0	0.91	21,0	0.83	41	--	0,210	0.463
26711-16-20Z*	-16	1.5/16"-12	32	-20	78,0	3.07	24,0	0.94	27,0	1.06	41	--	0,306	0.675
26711-20-16TZ***	-20	1.5/8"-12	25	-16	70,0	2.76	23,0	0.91	21,0	0.83	50	--	0,340	0.750
26711-20-20WZ**	-20	1.5/8"-12	32	-20	78,5	3.09	24,5	0.96	27,0	1.06	50	--	0,400	0.882
26711-24-20TZ***	-24	1.7/8"-12	32	-20	79,0	3.11	25,0	0.98	27,0	1.06	60	--	0,490	1.080
26711-24-24WZ**	-24	1.7/8"-12	38	-24	94,5	3.72	26,5	1.04	32,0	1.26	60	--	0,568	1.252
26711-32-24TZ***	-32	2.1/2"-12	38	-24	95,0	3.74	27,0	1.06	32,0	1.26	75	--	0,920	2.028
26711-32-32TZ***	-32	2.1/2"-12	50	-32	99,0	3.90	27,0	1.06	43,0	1.69	75	--	1,072	2.363



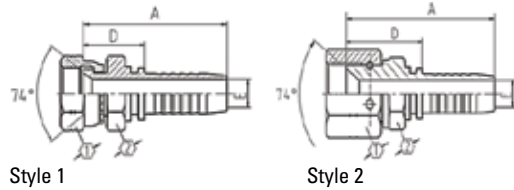

* Denotes Style 1 design
 ** Denotes Style 2 design
 *** Denotes Style 3 design

1. Same nipple configuration as 26711D without back up hex

Eaton Winner 2 piece braided hose fitting



JIC 37° Female Swivel

# Part Number	Terminal End	 Thread	 Hose Size		A		D Cut Off Factor		E Ø				 Weight	
			DN	Dash Size	mm	in	mm	in	mm	in			mm	mm
26711D-04-04Z*	-04	7/16"-20	6	-04	48,0	1.89	20,0	0.79	4,0	0.16	14	14	0,040	0.088
26711D-04-04SMZ*	-04	7/16"-20	6	-04	48,0	1.89	20,0	0.79	4,0	0.16	14	12	0,040	0.088
26711D-06-04Z*	-06	9/16"-18	6	-04	49,0	1.93	21,0	0.83	4,0	0.16	19	19	0,044	0.097
26711D-06-04SMZ*	-06	9/16"-18	6	-04	49,0	1.93	21,0	0.83	4,0	0.16	19	14	0,045	0.099
26711D-06-05Z*	-06	9/16"-18	8	-05	49,0	1.93	21,0	0.83	5,5	0.22	19	19	0,046	0.101
26711D-06-06Z*	-06	9/16"-18	10	-06	51,0	2.01	21,0	0.83	7,0	0.28	19	19	0,045	0.099
26711D-06-06SMZ*	-06	9/16"-18	10	-06	51,0	2.01	21,0	0.83	7,0	0.28	19	17	0,045	0.099
26711D-08-04Z*	-08	3/4"-16	6	-04	53,0	2.09	25,0	0.98	4,0	0.16	22	24	0,075	0.165
26711D-08-06Z*	-08	3/4"-16	10	-06	55,0	2.17	25,0	0.98	7,0	0.28	22	24	0,081	0.179
26711D-08-06SMZ*	-08	3/4"-16	10	-06	54,5	2.15	24,5	0.96	7,0	0.28	22	19	0,085	0.187
26711D-08-08Z*	-08	3/4"-16	12	-08	56,0	2.20	24,5	0.96	9,9	0.39	22	24	0,080	0.176
26711D-08-08SMZ*	-08	3/4"-16	12	-08	55,0	2.17	23,5	0.93	9,9	0.39	22	19	0,085	0.187
26711D-10-08Z*	-10	7/8"-14	12	-08	57,5	2.26	26,0	1.02	10,0	0.39	27	27	0,108	0.238
26711D-10-08SMZ*	-10	7/8"-14	12	-08	57,5	2.26	26,0	1.02	10,0	0.39	27	22	0,104	0.229
26711D-10-10Z*	-10	7/8"-14	16	-10	61,0	2.40	27,0	1.06	12,0	0.47	27	27	0,120	0.265
26711D-10-10SMZ*	-10	7/8"-14	16	-10	61,0	2.40	27,0	1.06	12,0	0.47	27	22	0,104	0.229
26711D-12-08SMZ*	-12	1.1/16"-12	12	-08	61,0	2.40	29,5	1.16	10,0	0.39	32	27	0,166	0.366
26711D-12-10Z*	-12	1.1/16"-12	16	-10	65,0	2.56	31,0	1.22	12,0	0.47	32	32	0,180	0.397
26711D-12-12Z*	-12	1.1/16"-12	20	-12	70,0	2.76	31,5	1.24	15,0	0.59	32	32	0,188	0.414
26711D-12-12SMZ*	-12	1.1/16"-12	20	-12	70,0	2.76	31,5	1.24	15,0	0.59	32	27	0,166	0.366
26711D-16-16Z*	-16	1.5/16"-12	25	-16	81,5	3.21	34,5	1.36	21,0	0.83	41	41	0,320	0.705
26711D-16-16SMWZ**	-16	1.5/16"-12	25	-16	84,5	3.33	37,5	1.48	21,0	0.83	41	32	0,312	0.688
26711D-20-20SMWZ**	-20	1.5/8"-12	32	-20	95,0	3.74	41,0	1.61	27,0	1.06	50	41	0,502	1.107
26711D-32-32SMWZ**	-32	2.1/2"-12	50	-32	117,0	4.61	45,0	1.77	43,0	1.69	75	65	1,380	3.042
26711D-24-24SMWZ**	-24	1.7/8"-12	38	-24	110,0	4.33	42,0	1.65	32,0	1.26	60	46	0,665	1.466

* Denotes Style 1 design





** Denotes Style 2 design

1. Same nipple configuration as 26711 with back up hex

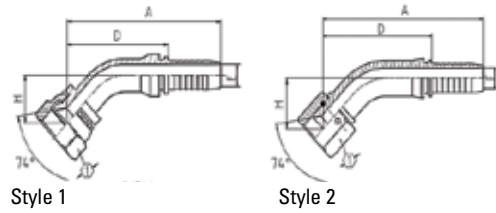
Eaton Winner 2 piece braided hose fitting

JIC 37° Female 45° Elbow



# Part Number	Terminal End	 Thread	 Hose Size		A				D Cut Off Factor		E Ø		H				 Weight	
					mm	in	mm	in	mm	in	mm	in	mm	mm			kg	lb
26741-04-03Z*	-04	7/16"-20	5	-03	54,0	2.13	32,5	1.28	3,0	0.12	12,1	0.48	14	--	0,029	0.064		
26741-04-04Z*	-04	7/16"-20	6	-04	63,1	2.48	35,1	1.38	4,0	0.16	13,0	0.51	14	--	0,035	0.077		
26741-04-06Z*	-04	7/16"-20	10	-06	65,2	2.57	35,2	1.39	7,0	0.28	13,1	0.52	14	--	0,036	0.079		
26741-05-04Z*	-05	1/2"-20	6	-04	63,6	2.50	35,6	1.40	4,0	0.16	13,5	0.53	17	--	0,038	0.084		
26741-05-05Z*	-05	1/2"-20	8	-05	65,7	2.59	37,7	1.48	5,5	0.22	14,4	0.57	17	--	0,050	0.110		
26741-06-04Z*	-06	9/16"-18	6	-04	63,6	2.50	35,6	1.40	4,0	0.16	13,5	0.53	19	--	0,045	0.099		
26741-06-05Z*	-06	9/16"-18	8	-05	65,7	2.59	37,7	1.48	5,5	0.22	14,4	0.57	19	--	0,056	0.123		
26741-06-06Z*	-06	9/16"-18	10	-06	68,8	2.71	38,8	1.53	7,0	0.28	14,8	0.58	19	--	0,062	0.137		
26741-06-08Z*	-06	9/16"-18	12	-08	70,8	2.79	39,3	1.55	10,0	0.39	14,8	0.58	19	--	0,064	0.141		
26741-06-10Z*	-06	9/16"-18	16	-10	75,8	2.98	41,8	1.65	12,0	0.47	14,8	0.58	19	--	0,068	0.150		
26741-08-06Z*	-08	3/4"-16	10	-06	70,2	2.76	40,2	1.58	7,0	0.28	16,2	0.64	22	--	0,080	0.176		
26741-08-08Z*	-08	3/4"-16	12	-08	76,8	3.02	45,3	1.78	10,0	0.39	19,0	0.75	22	--	0,105	0.231		
26741-08-10Z*	-08	3/4"-16	16	-10	87,7	3.45	53,7	2.11	12,0	0.47	21,4	0.84	22	--	0,120	0.265		
26741-10-06Z*	-10	7/8"-14	10	-06	71,6	2.82	41,6	1.64	7,0	0.28	17,6	0.69	27	--	0,092	0.203		
26741-10-08Z*	-10	7/8"-14	12	-08	78,2	3.08	46,7	1.84	10,0	0.39	20,4	0.80	27	--	0,120	0.265		
26741-10-10Z*	-10	7/8"-14	16	-10	88,4	3.48	54,4	2.14	12,0	0.47	22,1	0.87	27	--	0,146	0.322		
26741-10-12Z*	-10	7/8"-14	20	-12	98,4	3.87	58,9	2.32	15,0	0.59	22,1	0.87	27	--	0,170	0.375		
26741-12-08Z*	-12	1.1/16"-12	12	-08	81,9	3.22	50,4	1.98	10,0	0.39	21,1	0.83	32	--	0,140	0.309		
26741-12-10Z*	-12	1.1/16"-12	16	-10	89,1	3.51	55,1	2.17	12,0	0.47	22,8	0.90	32	--	0,202	0.445		
26741-12-12Z*	-12	1.1/16"-12	20	-12	97,8	3.85	59,3	2.33	15,0	0.59	24,2	0.95	32	--	0,240	0.529		
26741-12-16Z*	-12	1.1/16"-12	25	-16	117,3	4.62	70,3	2.77	21,0	0.83	24,2	0.95	32	--	0,278	0.613		
26741-14-12Z*	-14	1.3/16"-12	20	-12	98,6	3.88	60,1	2.37	15,0	0.59	24,2	0.95	36	--	0,230	0.507		
26741-16-12Z*	-16	1.5/16"-12	20	-12	99,4	3.91	60,9	2.40	15,0	0.59	25,0	0.98	41	--	0,346	0.763		
26741-16-16Z*	-16	1.5/16"-12	25	-16	121,3	4.78	74,3	2.93	21,0	0.83	28,7	1.13	41	--	0,400	0.882		
26741-20-16WZ**	-20	1.5/8"-12	25	-16	123,6	4.87	76,6	3.02	21,0	0.83	31,1	1.22	50	--	0,536	1.182		
26741-20-20WZ**	-20	1.5/8"-12	32	-20	150,3	5.92	96,3	3.79	27,0	1.06	35,5	1.40	50	--	0,650	1.433		
26741-24-20WZ**	-24	1.7/8"-12	32	-20	140,6	5.54	86,6	3.41	27,0	1.06	35,9	1.41	60	--	0,780	1.720		
26741-24-24WZ**	-24	1.7/8"-12	38	-24	182,8	7.20	114,8	4.52	32,0	1.26	44,1	1.74	60	--	1,122	2.474		
26741-32-32WZ**	-32	2.1/2"-12	50	-32	207,9	8.19	135,9	5.35	43,0	1.69	51,6	2.03	75	--	2,076	4.577		



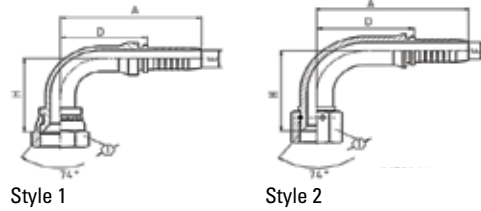

* Denotes Style 1 design

** Denotes Style 2 design

Eaton Winner 2 piece braided hose fitting



JIC 37° Female 90° Elbow

# Part Number	Terminal End	 Thread	 Hose Size		A		D Cut Off Factor		E Ø		H				 Weight	
			Dash Size	DN	Dash Size	mm	in	mm	in	mm	in	mm	in	mm	mm	kg
26791-04-03Z*	-04	7/16"-20	5	-03	48,0	1.89	26,5	1.04	3,0	0.12	23,3	0.92	14	--	0,024	0.053
26791-04-04Z*	-04	7/16"-20	6	-04	58,0	2.28	30,0	1.18	4,0	0.16	26,3	1.04	14	--	0,040	0.088
26791-04-05Z*	-04	7/16"-20	8	-05	58,0	2.28	30,0	1.18	5,5	0.22	26,3	1.04	14	--	0,040	0.088
26791-04-06Z*	-04	7/16"-20	10	-06	60,0	2.36	30,0	1.18	7,0	0.28	26,3	1.04	14	--	0,040	0.088
26791-05-04Z*	-05	1/2"-20	6	-04	58,0	2.28	30,0	1.18	4,0	0.16	27,0	1.06	17	--	0,042	0.093
26791-05-05Z*	-05	1/2"-20	8	-05	61,0	2.40	33,0	1.30	5,5	0.22	30,0	1.18	17	--	0,050	0.110
26791-05-06Z*	-05	1/2"-20	10	-06	63,0	2.48	33,0	1.30	7,0	0.28	30,0	1.18	17	--	0,055	0.121
26791-06-04Z*	-06	9/16"-18	6	-04	58,0	2.28	30,0	1.18	4,0	0.16	27,0	1.06	19	--	0,048	0.106
26791-06-05Z*	-06	9/16"-18	8	-05	61,0	2.40	33,0	1.30	5,5	0.22	30,0	1.18	19	--	0,062	0.137
26791-06-06Z*	-06	9/16"-18	10	-06	64,5	2.54	34,5	1.36	7,0	0.28	31,5	1.24	19	--	0,070	0.154
26791-06-08Z*	-06	9/16"-18	12	-08	69,5	2.74	38,0	1.50	10,0	0.39	31,5	1.24	19	--	0,070	0.154
26791-08-04Z*	-08	3/4"-16	6	-04	58,0	2.28	30,0	1.18	4,0	0.16	29,0	1.14	22	--	0,063	0.139
26791-08-06Z*	-08	3/4"-16	10	-06	64,5	2.54	34,5	1.36	7,0	0.28	33,5	1.32	22	--	0,088	0.194
26791-08-08Z*	-08	3/4"-16	12	-08	71,0	2.80	39,5	1.56	10,0	0.39	40,0	1.57	22	--	0,118	0.260
26791-08-10Z*	-08	3/4"-16	16	-10	81,5	3.21	45,5	1.79	12,0	0.47	40,0	1.57	22	--	0,124	0.273
26791-08-12Z*	-08	3/4"-16	20	-12	86,5	3.41	48,0	1.89	15,0	0.59	40,0	1.57	22	--	0,134	0.295
26791-10-06Z*	-10	7/8"-14	10	-06	66,5	2.62	36,5	1.44	7,0	0.28	34,5	1.36	27	--	0,100	0.220
26791-10-08Z*	-10	7/8"-14	12	-08	71,0	2.80	39,5	1.56	10,0	0.39	42,0	1.65	27	--	0,132	0.291
26791-10-10Z*	-10	7/8"-14	16	-10	83,0	3.27	49,0	1.93	12,0	0.47	47,5	1.87	27	--	0,190	0.419
26791-10-12Z*	-10	7/8"-14	20	-12	92,0	3.62	53,5	2.11	15,0	0.59	47,5	1.87	27	--	0,196	0.432
26791-12-08Z*	-12	1.1/16"-12	12	-08	75,0	2.95	43,5	1.71	10,0	0.39	43,0	1.69	32	--	0,150	0.331
26791-12-10Z*	-12	1.1/16"-12	16	-10	83,0	3.27	49,0	1.93	12,0	0.47	49,0	1.93	32	--	0,226	0.498
26791-12-12Z*	-12	1.1/16"-12	20	-12	93,0	3.66	54,5	2.15	15,0	0.59	53,5	2.11	32	--	0,300	0.661
26791-12-16Z*	-12	1.1/16"-12	25	-16	112,5	4.43	65,5	2.58	21,0	0.83	53,5	2.11	32	--	0,320	0.705
26791-14-12Z*	-14	1.3/16"-12	20	-12	93,8	3.69	55,3	2.18	15,0	0.59	53,5	2.11	36	--	0,230	0.507
26791-16-12Z*	-16	1.5/16"-12	20	-12	93,8	3.69	55,3	2.18	15,0	0.59	53,6	2.11	41	--	0,408	0.899
26791-16-16Z*	-16	1.5/16"-12	25	-16	118,0	4.65	71,0	2.80	21,0	0.83	66,1	2.60	41	--	0,460	1.014
26791-16-20Z*	-16	1.5/16"-12	32	-20	135,0	5.31	81,0	3.19	27,0	1.06	66,1	2.60	41	--	0,576	1.270
26791-20-16WZ**	-20	1.5/8"-12	25	-16	118,0	4.65	71,0	2.80	21,0	0.83	69,5	2.74	50	--	0,630	1.389
26791-20-20WZ**	-20	1.5/8"-12	32	-20	135,5	5.33	81,5	3.21	27,0	1.06	80,0	3.15	50	--	0,784	1.728
26791-24-20WZ**	-24	1.7/8"-12	32	-20	135,5	5.33	81,5	3.21	27,0	1.06	81,5	3.21	60	--	0,860	1.896
26791-24-24WZ**	-24	1.7/8"-12	38	-24	177,4	6.98	109,4	4.31	32,0	1.26	94,0	3.70	60	--	1,386	3.056
26791-32-32WZ**	-32	2.1/2"-12	50	-32	205,1	8.07	133,1	5.24	43,0	1.69	121,8	4.80	75	--	2,600	5.732



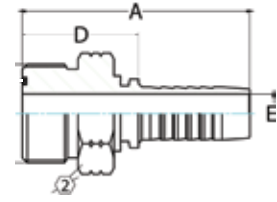

* Denotes Style 1 design

** Denotes Style 2 design

Eaton Winner 2 piece braided hose fitting



ORS Male Rigid

# Part Number	Terminal End	 Thread	 Hose Size		A		D Cut Off Factor		E Ø				 Weight	
			Dash Size	DN	Dash Size	mm	in	mm	in	mm			in	mm
14211-04-04Z	-04	9/16"x18	6	-04	50,5	1.99	22,5	0.89	4,0	0.16	--	17	0,030	0.066
14211-06-04Z	-06	11/16"x16	6	-04	52,0	2.05	24,0	0.94	4,0	0.16	--	19	0,038	0.084
14211-06-06Z	-06	11/16"x16	10	-06	54,0	2.13	24,0	0.94	6,7	0.26	--	19	0,040	0.088
14211-08-06Z	-08	13/16"x16	10	-06	57,5	2.26	27,5	1.08	7,0	0.28	--	22	0,060	0.132
14211-08-08Z	-08	13/16"x16	12	-08	60,0	2.36	28,5	1.12	9,6	0.38	--	22	0,070	0.154
14211-10-08Z	-10	1"x14	12	-08	64,0	2.52	32,5	1.28	10,0	0.39	--	27	0,108	0.238
14211-10-10Z	-10	1"x14	16	-10	67,5	2.66	33,5	1.32	12,0	0.47	--	27	0,120	0.264
14211-12-08Z	-12	1.3/16"x12	12	-08	67,0	2.64	35,5	1.40	10,0	0.39	--	32	0,148	0.326
14211-12-10Z	-12	1.3/16"x12	16	-10	70,0	2.76	36,0	1.42	12,0	0.47	--	32	0,164	0.361
14211-12-12Z	-12	1.3/16"x12	20	-12	75,0	2.95	36,5	1.44	15,0	0.59	--	32	0,172	0.378
14211-16-12Z	-16	1.7/16"x12	20	-12	75,5	2.97	37,0	1.46	15,0	0.59	--	38	0,255	0.561
14211-16-16Z	-16	1.7/16"x12	25	-16	85,5	3.37	38,5	1.52	20,6	0.81	--	38	0,248	0.546
14211-20-20Z	-20	1.11/16"x12	32	-20	95,5	3.76	41,5	1.63	26,0	1.02	--	46	0,400	0.880
14211-24-24Z	-24	2"x12	40	-24	114,5	4.51	46,5	1.83	32,0	1.26	--	55	0,624	1.373

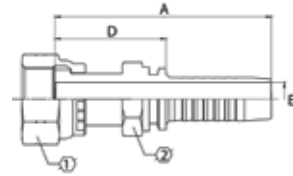

ORS Female Swivel





# Part Number	Terminal End	 Thread	 Hose Size		A		D Cut Off Factor		E Ø				 Weight	
			Dash Size	DN	Dash Size	mm	in	mm	in	mm			in	mm
24211D-04-04SMZ	-04	9/16"x18	6	-04	55,5	2.19	27,5	1.08	4,0	0.16	17	14	0,041	0.090
24211D-06-06SMZ	-06	11/16"x16	10	-06	60,0	2.36	30,0	1.18	7,0	0.28	22	17	0,060	0.132
24211D-08-08SMZ	-08	13/16"x16	12	-08	65,0	2.56	33,5	1.32	10,0	0.39	27	19	0,096	0.212
24211D-10-10SMZ	-10	1"x14	16	-10	74,0	2.91	40,0	1.57	12,0	0.47	30	24	0,140	0.309
24211D-12-12SMZ	-12	1.3/16"x12	20	-12	83,8	3.30	45,3	1.78	15,0	0.59	36	30	0,195	0.430
24211D-16-16SMZ	-16	1.7/16"x12	25	-16	95,5	3.76	48,5	1.91	21,0	0.83	41	32	0,260	0.573

1. Same nipple configuration as 24211 with back up hex

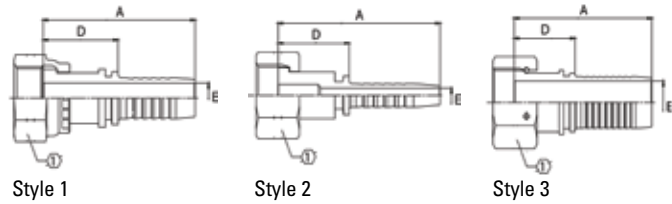
Eaton Winner 2 piece braided hose fitting

ORS Female Swivel



# Part Number	Terminal End	 Thread	 Hose Size		A		D Cut Off Factor		E Ø				 Weight	
			DN	Dash Size	mm	in	mm	in	mm	in	mm	mm	kg	lb
24211-04-04Z*	-04	9/16"×18	6	-04	50,5	1.99	22,5	0.89	4,0	0.16	17	--	0,034	0.075
24211-04-06Z*	-04	9/16"×18	10	-06	52,5	2.07	22,5	0.89	7,0	0.28	17	--	0,043	0.095
24211-06-04TZ**	-06	11/16"×16	6	-04	51,5	2.03	23,5	0.93	4,0	0.16	22	--	0,060	0.132
24211-06-05TZ**	-06	11/16"×16	8	-05	51,5	2.03	23,5	0.93	5,5	0.22	22	--	0,065	0.143
24211-06-06Z*	-06	11/16"×16	10	-06	55,5	2.19	25,5	1	7,0	0.28	22	--	0,055	0.121
24211-08-06TZ**	-08	13/16"×16	10	-06	55,0	2.17	25,0	0.98	7,0	0.28	24	--	0,095	0.209
24211-08-08Z*	-08	13/16"×16	12	-08	59,5	2.34	28,0	1.1	10,0	0.39	27	--	0,086	0.19
24211-10-08TZ**	-10	1"×14	12	-08	61,0	2.4	29,5	1.16	10,0	0.39	30	--	0,130	0.287
24211-10-10Z*	-10	1"×14	16	-10	67,0	2.64	33,0	1.3	12,0	0.47	30	--	0,120	0.265
24211-10-12Z*	-10	1"×14	20	-12	72,0	2.83	33,5	1.32	15,0	0.59	30	--	0,146	0.322
24211-12-08TZ**	-12	1.3/16"×12	12	-08	62,0	2.44	30,5	1.2	10,0	0.39	36	--	0,185	0.408
24211-12-10TZ**	-12	1.3/16"×12	16	-10	65,5	2.58	31,5	1.24	12,0	0.47	36	--	0,210	0.463
24211-12-12Z*	-12	1.3/16"×12	20	-12	73,5	2.89	35,0	1.38	15,0	0.59	36	--	0,195	0.43
24211-12-16Z*	-12	1.3/16"×12	25	-16	83,0	3.27	36,0	1.42	21,0	0.83	36	--	0,236	0.52
24211-16-12TZ**	-16	1.7/16"×12	20	-12	73,5	2.89	35,0	1.38	15,0	0.59	41	--	0,250	0.551
24211-16-16TZ**	-16	1.7/16"×12	25	-16	82,0	3.23	35,0	1.38	21,0	0.83	41	--	0,260	0.573
24211-20-16TZ***	-20	1.11/16"×12	25	-16	81,5	3.21	34,5	1.36	21,0	0.83	50	--	0,385	1.849
24211-20-20WZ***	-20	1.11/16"×12	32	-20	96,5	3.8	42,5	1.67	27,0	1.06	50	--	0,464	1.023
24211-24-24TZ**	-24	2"×12	40	-24	104,0	4.09	36,0	1.42	32,0	1.26	60	--	0,660	1.455

* Denotes Style 1 design

** Denotes Style 2 design

*** Denotes Style 3 design

1. Same nipple configuration as 24211D without back up hex

Eaton Winner 2 piece braided hose fitting

ORS Female 45° Elbow

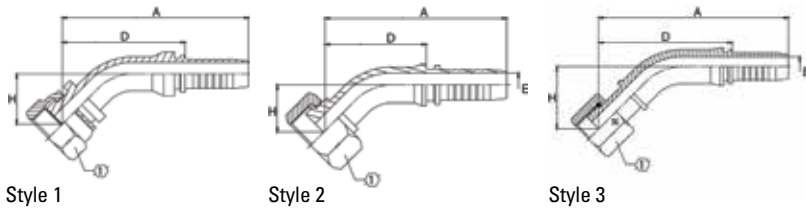

# Part Number	Terminal End	Thread	Hose Size		A		D Cut Off Factor		E Ø		H		①	②	Weight	
			DN	Dash Size	mm	in	mm	in	mm	in	mm	in			mm	mm
24241-04-04Z*	-04	9/16"×18	6	-04	73,5	2.89	45,5	1.79	4,0	0.16	23,4	0.92	17	--	0,046	0.101
24241-04-06Z*	-04	9/16"×18	10	-06	75,6	2.98	45,6	1.80	7,0	0.28	23,4	0.92	17	--	0,056	0.123
24241-06-04TZ**	-06	11/16"×16	6	-04	68,9	2.71	40,9	1.61	4,0	0.16	18,8	0.74	22	--	0,070	0.154
24241-06-06Z*	-06	11/16"×16	10	-06	81,3	3.20	51,3	2.02	7,0	0.28	27,1	1.07	22	--	0,078	0.172
24241-06-08Z*	-06	11/16"×16	12	-08	95,7	3.77	64,2	2.53	10,0	0.39	29,3	1.15	22	--	0,132	0.291
24241-08-06TZ**	-08	13/16"×16	10	-06	74,6	2.94	44,6	1.76	7,0	0.28	20,3	0.80	24	--	0,110	0.243
24241-08-08Z*	-08	13/16"×16	12	-08	97,2	3.83	65,7	2.59	10,0	0.39	30,7	1.21	27	--	0,100	0.220
24241-10-08TZ**	-10	1"×14	12	-08	89,7	3.53	58,2	2.29	10,0	0.39	23,3	0.92	30	--	0,162	0.357
24241-10-10Z*	-10	1"×14	16	-10	113,2	4.46	79,2	3.12	12,0	0.47	34,9	1.37	30	--	0,210	0.463
24241-10-12Z*	-10	1"×14	20	-12	124,4	4.90	85,9	3.38	15,0	0.59	38,5	1.52	30	--	0,326	0.719
24241-12-08TZ**	-12	1.3/16"×12	12	-08	89,7	3.53	58,2	2.29	10,0	0.39	23,3	0.92	36	--	0,210	0.463
24241-12-12Z*	-12	1.3/16"×12	20	-12	125,5	4.94	87,0	3.43	15,0	0.59	39,5	1.56	36	--	0,350	0.772
24241-12-16TZ*	-12	1.3/16"×12	25	-16	139,3	5.48	92,3	3.63	21,0	0.83	41,0	1.61	36	--	0,524	1.155
24241-16-16TZ*	-16	1.7/16"×12	25	-16	131,1	5.16	84,1	3.31	21,0	0.83	29,7	1.17	41	--	0,423	0.933
24241-20-20VZ***	-20	1.11/16"×12	32	-20	165,2	6.50	111,2	4.38	27,0	1.06	49,0	1.93	50	--	0,740	1.631
24241-24-24TZ**	-24	2"×12	40	-24	176,5	6.95	108,5	4.27	32,0	1.26	37,7	1.48	60	--	1,236	2.725

* Denotes Style 1 design
 ** Denotes Style 2 design
 *** Denotes Style 3 design

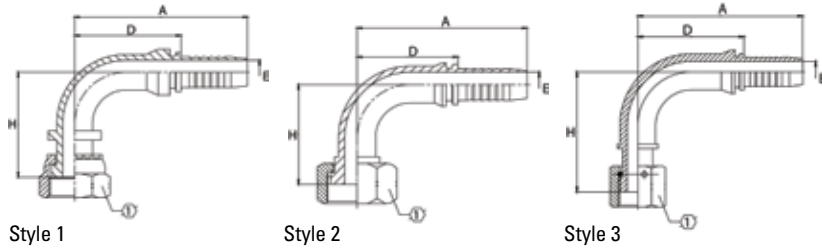

ORS Female 90° Elbow



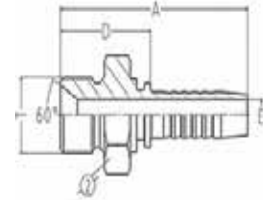

# Part Number	Terminal End	Thread	Hose Size		A		D Cut Off Factor		E Ø		H		①	②	Weight	
			DN	Dash Size	mm	in	mm	in	mm	in	mm	in			mm	mm
24291-04-04Z*	-04	9/16"×18	6	-04	58,0	2.28	30,0	1.18	4,0	0.16	41,0	1.61	17	--	0,052	0.115
24291-06-04TZ**	-06	11/16"×16	6	-04	58,0	2.28	30,0	1.18	4,0	0.16	34,5	1.36	22	--	0,065	0.143
24291-06-06Z*	-06	11/16"×16	10	-06	65,3	2.57	35,3	1.39	7,0	0.28	42,5	0.17	22	--	0,090	0.198
24291-06-08Z*	-06	11/16"×16	10	-06	67,3	2.65	35,8	1.41	10,0	0.39	49,3	1.94	22	--	0,098	0.216
24291-08-06TZ**	-08	13/16"×16	10	-06	65,3	2.57	35,3	1.39	7,0	0.28	39,8	1.56	24	--	0,120	0.265
24291-08-08Z*	-08	13/16"×16	12	-08	72,5	2.85	41,0	1.61	10,0	0.39	57,5	2.26	27	--	0,145	0.320
24291-10-08TZ**	-10	1"×14	12	-08	72,5	2.85	41,0	1.61	10,0	0.39	46,0	1.81	30	--	0,174	0.384
24291-10-10Z*	-10	1"×14	16	-10	90,0	3.54	56,0	2.20	12,0	0.47	66,0	2.60	30	--	0,235	0.518
24291-10-12Z*	-10	1"×14	20	-12	95,5	3.76	57,0	2.24	15,0	0.59	66,0	2.60	30	--	0,282	0.622
24291-12-12Z*	-12	1.3/16"×12	20	-12	104,0	4.09	65,5	2.58	15,0	0.59	77,0	3.03	36	--	0,390	0.860
24291-12-08TZ**	-12	1.3/16"×12	12	-8	84,0	3.31	52,5	2.07	10,0	0.39	51,5	2.03	36	--	0,282	0.622
24291-16-12TZ**	-16	1.7/16"×12	20	-12	104,0	4.09	65,5	2.58	15,0	0.59	63,0	2.48	41	--	0,410	0.904
24291-16-16TZ**	-16	1.7/16"×12	25	-16	123,9	4.88	76,9	3.03	21,0	0.83	67,5	2.66	41	--	0,504	1.111
24291-20-16TZ**	-20	1.11/16"×12	25	-16	123,7	4.87	76,7	3.02	21,0	0.83	67,5	2.66	50	--	0,622	1.371
24291-20-20VZ***	-20	1.11/16"×12	32	-20	147,0	5.79	93,0	3.66	27,0	1.06	100,0	3.94	50	--	0,862	1.900
24291-24-24TZ**	-24	2"×12	40	-24	177,4	6.98	109,4	4.31	32,0	1.26	92,0	3.62	60	--	1,372	3.025

* Denotes Style 1 design
 ** Denotes Style 2 design
 *** Denotes Style 3 design

Eaton Winner 2 piece braided hose fitting





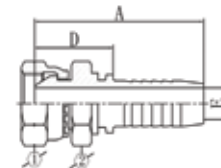

BSP 60° Cone Male Rigid

# Part Number	Terminal End	 Thread	 Hose Size		A		D Cut Off Factor		E Ø				 Weight	
	Dash Size		DN	Dash Size	mm	in	mm	in	mm	in	mm	mm	kg	lb
12611A-02-04Z	-02	G1/8"x28	6	-04	50,5	1.99	22,5	0.89	4,0	0.16	--	14,0	0,020	0.044
12611A-04-04Z	-04	G1/4"x19	6	-04	52,5	2.07	24,5	0.96	4,0	0.16	--	19,0	0,030	0.066
12611A-06-04Z	-06	G3/8"x19	6	-04	56,0	2.20	28,0	1.10	4,0	0.16	--	22,0	0,045	0.099
12611A-06-05Z	-06	G3/8"x19	8	-05	56,0	2.20	28,0	1.10	5,5	0.22	--	22,0	0,052	0.114
12611A-06-06Z	-06	G3/8"x19	10	-06	58,0	2.28	28,0	1.10	7,0	0.28	--	22,0	0,050	0.110
12611A-06-08Z	-06	G3/8"x19	12	-08	60,0	2.36	28,5	1.12	10,0	0.39	--	22,0	0,058	0.128
12611A-08-06Z	-08	G1/2"x14	10	-06	63,0	2.48	33,0	1.30	7,0	0.28	--	27,0	0,082	0.180
12611A-08-08Z	-08	G1/2"x14	12	-08	64,5	2.54	33,0	1.30	10,0	0.39	--	27,0	0,090	0.198
12611A-10-10Z	-10	G5/8"x14	16	-10	69,5	2.74	35,5	1.40	12,0	0.47	--	30,0	0,121	0.266
12611A-12-12Z	-12	G3/4"x14	20	-12	76,0	2.99	37,5	1.48	15,0	0.59	--	32,0	0,150	0.330
12611A-16-12Z	-16	G1"x11	20	-12	81,0	3.19	42,5	1.67	15,0	0.59	--	41,0	0,230	0.506
12611A-16-16Z	-16	G1"x11	25	-16	90,5	3.56	43,5	1.71	21,0	0.83	--	41,0	0,253	0.557
12611A-20-20Z	-20	G1.1/4"x11	32	-20	100,0	3.94	46,5	1.83	27,0	1.06	--	50,0	0,406	0.893
12611A-24-24Z	-24	G1.1/2"x11	40	-24	117,0	4.61	49,0	1.93	32,0	1.26	--	55,0	0,554	1.219



BSP 60° Cone Female Swivel

# Part Number	Terminal End	 Thread	 Hose Size		A		D Cut Off Factor		E Ø				 Weight	
	Dash Size		DN	Dash Size	mm	in	mm	in	mm	in	mm	mm	kg	lb
22611D-04-04Z	-04	G1/4"X19	6	-04	51,5	2.03	32,5	1.28	4,0	0.16	19	19	0,044	0.097
22611D-06-06Z	-06	G3/8"X19	10	-06	56,5	2.22	26,5	1.04	7,0	0.28	22	22	0,065	0.143
22611D-08-08Z	-08	G1/2"X14	12	-08	62,5	2.46	31,0	1.22	10,0	0.39	27	27	0,120	0.264
22611D-12-12Z	-12	G3/4"X14	20	-12	72,0	2.83	33,5	1.32	15,0	0.59	32	32	0,190	0.418
22611D-16-16Z	-16	G1"X11	25	-16	82,5	3.25	35,5	1.40	21,0	0.83	41	41	0,296	0.651

1. Same nipple configuration as 26611 with back up hex

Eaton Winner 2 piece braided hose fitting

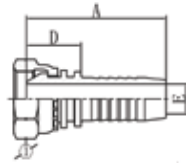

Style 1

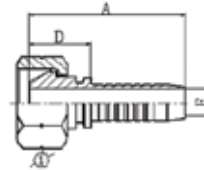

Style 2

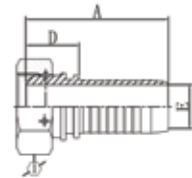

Style 3

BSP 60° Cone Female Swivel

# Part Number	Terminal End	Thread	Hose Size		A		D Cut Off Factor		E Ø		1	2	Weight	
			DN	Dash Size	mm	in	mm	in	mm	in			mm	mm
22611-04-04Z*	-04	G1/4"X19	6	-04	46,0	1.81	18,0	0.71	4,0	0.16	19	--	0,032	0.070
22611-04-05Z*	-04	G1/4"X19	8	-05	46,0	1.81	18,0	0.71	5,0	0.20	19	--	0,035	0.077
22611-04-06Z*	-04	G1/4"X19	10	-06	48,0	1.89	18,0	0.71	7,0	0.28	19	--	0,040	0.088
22611-06-04TZ**	-06	G3/8"X19	6	-04	45,5	1.79	17,5	0.69	4,0	0.16	22	--	0,050	0.110
22611-06-05Z*	-06	G3/8"X19	8	-05	47,0	1.85	19,0	0.75	5,5	0.22	22	--	0,044	0.097
22611-06-06Z*	-06	G3/8"X19	10	-06	49,5	1.95	19,5	0.77	7,0	0.28	22	--	0,046	0.101
22611-06-08Z*	-06	G3/8"X19	12	-08	51,0	2.01	19,5	0.77	10,0	0.39	22	--	0,060	0.132
22611-08-06TZ**	-08	G1/2"X14	10	-06	48,5	1.91	18,5	0.73	7,0	0.28	27	--	0,080	0.176
22611-08-08Z*	-08	G1/2"X14	12	-08	53,0	2.09	21,5	0.85	10,0	0.39	27	--	0,078	0.172
22611-08-10Z*	-08	G1/2"X14	16	-10	56,5	2.22	22,5	0.89	12,0	0.47	27	--	0,092	0.202
22611-10-08Z*	-10	G5/8"X14	12	-08	53,5	2.11	22,0	0.87	10,0	0.39	30	--	0,100	0.220
22611-10-10Z*	-10	G5/8"X14	16	-10	57,0	2.24	23,0	0.91	12,0	0.47	30	--	0,114	0.251
22611-12-08TZ**	-12	G3/4"X14	12	-08	51,5	2.03	20,0	0.79	10,0	0.39	32	--	0,130	0.286
22611-12-10Z*	-12	G3/4"X14	16	-10	57,5	2.26	23,5	0.93	12,0	0.47	32	--	0,126	0.277
22611-12-12Z*	-12	G3/4"X14	20	-12	62,5	2.46	24,0	0.94	15,0	0.59	32	--	0,132	0.290
22611-16-12TZ**	-16	G1"X11	20	-12	61,5	2.42	23,0	0.91	15,0	0.59	41	--	0,220	0.484
22611-16-16Z*	-16	G1"X11	25	-16	74,0	2.91	27,0	1.06	21,0	0.83	41	--	0,226	0.497
22611-20-16TZ**	-20	G1.1/4"X11	25	-16	74,0	2.91	27,0	1.06	21,0	0.83	50	--	0,350	0.770
22611-24-20TZ**	-24	G1.1/2"X11	32	-20	83,5	3.29	29,5	1.16	27,0	1.06	55	--	0,466	1.025
22611-20-20WZ***	-20	G1.1/4"X11	32	-20	84,5	3.33	30,5	1.20	27,0	1.06	50	--	0,406	0.893
22611-24-24WZ***	-24	G1.1/2"X11	40	-24	100,0	3.94	32,0	1.26	32,0	1.26	55	--	0,546	1.201
22611-32-32WZ***	-32	G2"X11	50	-32	103,0	4.06	31,0	1.22	43,0	1.69	70	--	0,960	2.112

* Denotes Style 1 design

** Denotes Style 2 design

*** Denotes Style 3 design

1. Same nipple configuration as 22611D without back up hex

Eaton Winner 2 piece braided hose fitting

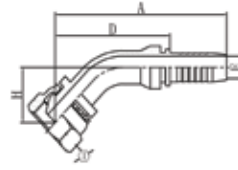

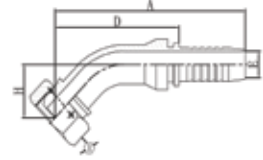

Style 1



Style 2

BSP 60° Cone Female 45° Elbow

# Part Number	Terminal End	 Thread	 Hose Size		A		D Cut Off Factor		E Ø		H		1	2	 Weight	
			Dash Size	DN	Dash Size	mm	in	mm	in	mm	in	mm	in	mm	mm	kg
22641-04-04Z*	-04	G1/4"X19	6	-04	70,3	2.77	42,3	1.67	4,0	0.16	20,2	0.80	19	--	0,046	0.101
22641-06-04Z*	-06	G3/8"X19	6	-04	71,2	2.80	43,2	1.70	4,0	0.16	21,1	0.83	22	--	0,055	0.121
22641-06-06Z*	-06	G3/8"X19	10	-06	76,9	3.03	46,9	1.85	7,0	0.28	22,6	0.89	22	--	0,070	0.154
22641-08-06Z	-06	G1/2"X14	10	-06	76,7	3.02	46,7	1.84	7,0	0.28	22,5	0.89	27	--	0,104	0.229
22641-08-08Z*	-08	G1/2"X14	12	-08	92,6	3.65	61,1	2.41	10,0	0.39	26,1	1.03	27	--	0,130	0.286
22641-10-10Z*	-10	G5/8"X14	16	-10	106,1	4.18	72,1	2.84	12,0	0.47	27,8	1.09	30	--	0,196	0.431
22641-12-12Z*	-12	G3/4"X14	20	-12	117,1	4.61	78,6	3.09	15,0	0.59	31,8	1.25	32	--	0,285	0.627
22641-16-16Z*	-16	G1"X11	25	-16	135,4	5.33	88,4	3.48	21,0	0.83	34,2	1.35	41	--	0,402	0.884
22641-20-20WZ**	-20	G1.1/4"X11	32	-20	152,8	6.02	98,8	3.89	27,0	1.06	38,0	1.50	50	--	0,650	1.430
22641-24-24WZ**	-24	G1.1/2"X11	40	-24	184,2	7.25	116,2	4.57	32,0	1.26	45,5	1.79	55	--	1,095	2.409
22641-32-32WZ**	-32	G2"X11	50	-32	207,7	8.18	135,7	5.34	43,0	1.69	52,7	2.07	70	--	1,898	4.176

* Denotes Style 1 design

** Denotes Style 2 design

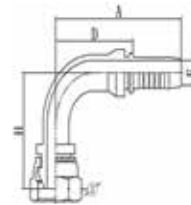

Style 1

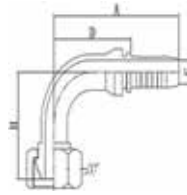

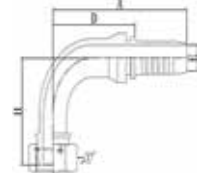

Style 2



Style 3

BSP 60° Cone Female 90° Elbow

# Part Number	Terminal End	 Thread	 Hose Size		A		D Cut Off Factor		E Ø		H		1	2	 Weight	
			Dash Size	DN	Dash Size	mm	in	mm	in	mm	in	mm	in	mm	mm	kg
22691-04-04Z*	-04	G1/4"X19	6	-04	58,0	2.28	30,0	1.18	4,0	0.16	36,5	1.44	19	--	0,048	0.106
22691-04-05Z*	-04	G1/4"X19	8	-05	61,0	2.40	33,0	1.30	5,5	0.22	39,5	1.56	19	--	0,060	0.132
22691-04-06Z*	-04	G1/4"X19	10	-06	60,0	2.36	30,0	1.18	7,0	0.28	36,5	1.44	19	--	0,055	0.121
22691-06-04TZ*	-06	G3/8"X19	6	-04	58,0	2.28	30,0	1.18	4,0	0.16	35,7	1.41	22	--	0,070	0.154
22691-06-06Z*	-06	G3/8"X19	10	-06	65,3	2.57	35,3	1.39	7,0	0.28	43,0	1.69	22	--	0,080	0.176
22691-06-08Z*	-06	G3/8"X19	12	-08	72,5	2.85	41,0	1.61	10,0	0.39	49,2	1.94	22	--	0,126	0.277
22691-08-06TZ*	-08	G1/2"X14	10	-06	65,3	2.57	35,3	1.39	7,0	0.28	41,8	1.65	27	--	0,115	0.253
22691-08-08Z*	-08	G1/2"X14	12	-08	72,5	2.85	41,0	1.61	10,0	0.39	51,0	2.01	27	--	0,134	0.293
22691-10-08Z*	-10	G5/8"X14	12	-08	72,5	2.85	41,0	1.61	10,0	0.39	51,5	2.03	30	--	0,160	0.352
22691-10-10Z*	-10	G5/8"X14	16	-10	90,0	3.54	56,0	2.20	12,0	0.47	56,0	2.20	30	--	0,218	0.480
22691-12-10Z*	-12	G3/4"X14	16	-10	90,0	3.54	56,0	2.20	12,0	0.47	56,6	2.23	32	--	0,228	0.502
22691-12-12Z*	-12	G3/4"X14	20	-12	103,4	4.07	64,9	2.56	15,0	0.59	66,0	2.60	32	--	0,330	0.726
22691-16-12TZ**	-16	G1"X11	20	-12	104,0	4.09	65,5	2.58	15,0	0.59	63,8	2.51	41	--	0,360	0.660
22691-16-16Z*	-16	G1"X11	25	-16	123,7	4.87	76,7	3.02	21,0	0.83	73,8	2.91	41	--	0,495	1.089
22691-20-20WZ***	-20	G1.1/4"X11	32	-20	145,5	5.73	91,5	3.60	27,0	1.06	84,3	3.32	50	--	0,775	1.705
22691-24-24WZ***	-24	G1.1/2"X11	40	-24	177,4	6.98	109,4	4.31	32,0	1.26	103,0	4.06	55	--	1,395	3.069
22691-32-32WZ***	-32	G2"X11	50	-32	203,8	8.02	131,8	5.19	43,0	1.69	123,3	4.85	70	--	2,360	5.192

* Denotes Style 1 design



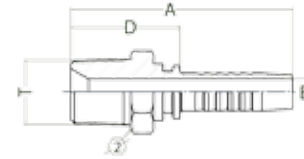

** Denotes Style 2 design

*** Denotes Style 3 design

Eaton Winner 2 piece braided hose fitting



NPTF Male Rigid

# Part Number	Terminal End	 Thread	 Hose Size		A		D Cut Off Factor		E Ø				 Weight	
	Dash Size		DN	Dash Size	mm	in	mm	in	mm	in	mm	mm	kg	lb
15611-F02-04Z	-02	1/8"x27	6	-04	50,5	1.99	22,5	0.89	4,0	0.16	--	12	0,015	0.033
15611-F04-04Z	-04	1/4"x18	6	-04	56,0	2.20	28,0	1.10	4,0	0.16	--	17	0,030	0.066
15611-F04-05Z	-04	1/4"x18	8	-05	56,0	2.20	28,0	1.10	4,0	0.16	--	17	0,030	0.066
15611-F04-06Z	-04	1/4"x18	10	-06	57,5	2.26	27,5	1.08	7,0	0.28	--	17	0,032	0.070
15611-F06-04Z	-06	3/8"x18	6	-04	57,0	2.24	29,0	1.14	4,0	0.16	--	19	0,038	0.084
15611-F06-05Z	-06	3/8"x18	8	-05	57,0	2.24	29,0	1.14	5,5	0.22	--	19	0,044	0.097
15611-F06-06Z	-06	3/8"x18	10	-06	59,0	2.32	29,0	1.14	7,0	0.28	--	19	0,048	0.106
15611-F06-08Z	-06	3/8"x18	12	-08	62,0	2.44	30,5	1.20	9,0	0.35	--	19	0,060	0.132
15611-F08-04Z	-08	1/2"x14	6	-04	62,0	2.44	34,0	1.34	4,0	0.16	--	22	0,066	0.145
15611-F08-06Z	-08	1/2"x14	10	-06	64,0	2.52	34,0	1.34	7,0	0.28	--	22	0,068	0.150
15611-F08-08Z	-08	1/2"x14	12	-08	66,0	2.60	34,5	1.36	10,0	0.39	--	22	0,075	0.165
15611-F08-10Z	-08	1/2"x14	16	-10	69,5	2.74	35,5	1.40	12,0	0.47	--	22	0,085	0.187
15611-F08-12Z	-08	1/2"x14	20	-12	76,5	3.01	38,0	1.50	15,0	0.59	--	27	0,124	0.273
15611-F12-08Z	-12	3/4"x14	12	-08	69,0	2.72	37,5	1.48	10,0	0.39	--	27	0,103	0.227
15611-F12-10Z	-12	3/4"x14	16	-10	71,5	2.81	37,5	1.48	12,0	0.47	--	27	0,130	0.286
15611-F12-12Z	-12	3/4"x14	20	-12	77,0	3.03	38,5	1.52	15,0	0.59	--	27	0,130	0.286
15611-F12-16Z	-12	3/4"x14	25	-16	86,5	3.41	39,5	1.56	21,0	0.83	--	32	0,190	0.418
15611-F16-12Z	-16	1"x11.5	20	-12	83,5	3.29	45,0	1.77	15,0	0.59	--	36	0,210	0.462
15611-F16-16Z	-16	1"x11.5	25	-16	93,5	3.68	46,5	1.83	21,0	0.83	--	36	0,230	0.506
15611-F20-16Z	-20	1.1/4"x11.5	25	-16	96,5	3.80	49,5	1.95	21,0	0.83	--	46	0,344	0.757
15611-F20-20Z	-20	1.1/4"x11.5	32	-20	104,5	4.11	50,5	1.99	27,0	1.06	--	46	0,406	0.893
15611-F24-24Z	-24	1.1/2"x11.5	40	-24	119,0	4.69	51,0	2.01	32,0	1.26	--	50	0,550	1.210
15611-F32-32Z	-32	2"x11.5	50	-32	127,0	5.00	55,0	2.17	43,0	1.69	--	65	0,945	2.079

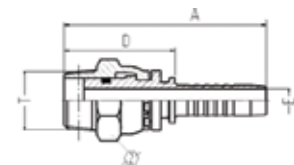

NPTF Male Swivel

# Part Number	Terminal End	 Thread	 Hose Size		A		D Cut Off Factor		E Ø				 Weight	
	Dash Size		DN	Dash Size	mm	in	mm	in	mm	in	mm	mm	kg	lb
15611SW-F04-04SZ	-04	1/4"x18	6	-04	76,0	2.99	48,0	1.89	4,0	0.16	--	19	0,064	0.141
15611SW-F06-06SZ	-06	3/8"x18	10	-06	85,0	3.35	55,0	2.17	7,0	0.28	--	22	0,100	0.220
15611SW-F08-06SZ	-08	1/2"x14	10	-06	87,0	3.43	57,0	2.24	7,0	0.28	--	22	0,152	0.334
15611SW-F08-08SZ	-08	1/2"x14	12	-08	88,5	3.49	57,0	2.24	10,0	0.39	--	27	0,152	0.334
15611SW-F12-12SZ	-12	3/4"x14	20	-12	99,0	3.90	60,5	2.38	15,0	0.59	--	32	0,225	0.495
15611SW-F16-16SZ	-16	1"x11.5	25	-16	116,5	4.59	69,5	2.74	21,0	0.83	--	41	0,375	0.825

1T/4S/6S Fitting series

DIN 24° DKO Light (DKO-L)

Male Rigid DIN 24 seat (DK)

I.Rh DKO (Light)
Straight

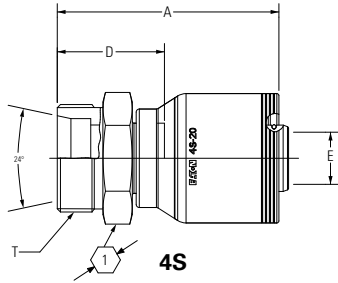

# Part Number	Tube O.D.	Hose Size		Thread	A		D		E Ø		1
		DN	Dash size		mm	in	mm	in	mm	in	
1T	Dash size	DN	Dash size	Metric	mm	in	mm	in	mm	in	mm
1T10DK6	12L	10	-6	M18X1,5	53.5	2.11	24	0.95	6.5	0.26	19
1T12DK8	15L	12	-8	M22X1,5	58	2.29	25	0.99	9.1	0.36	24
1T16DK10	18L	16	-10	M26X1,5	62	2.44	25.4	1.00	12.1	0.48	27

Female Swivel DIN 24° seat (DL)

I.Rh DKO (Light)
Straight

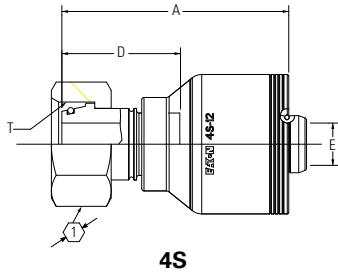

# Part Number	Tube O.D.	Hose Size		Thread	A		D		E Ø		1
		DN	Dash size		mm	in	mm	in	mm	in	
1T	Dash size	DN	Dash size	Metric	mm	in	mm	in	mm	in	mm
1T10DL6	12L	10	-6	M18X1,5	55	2.17	25.5	1.00	6.5	0.26	22
1T12DL8	15L	12	-8	M22X1,5	58	2.29	25	0.99	8	0.32	27
1T16DL10	18L	16	-10	M26X1,5	62	2.44	25.4	1.00	12.1	0.48	32
4S	Dash size	DN	Dash size	Metric	mm	in	mm	in	mm	in	mm
4S20DL12	22L	19	-12	M30X2	76,0	2.99	39,7	1.56	14,2	0.56	36,0
4S25DL16	28L	25	-16	M36X2	79,7	3.14	40,3	1.59	19,2	0.76	41,0
4S32DL20	35L	31	-20	M45X2	100,5	3.96	45,5	1.79	25,2	0.99	50,0

1T/4S/6S Fitting series

DIN 24° DKO Heavy (DKO-S)

Male DIN 24° Seat Rigid (EK)

S.Rh. DKO (Heavy)
Straight

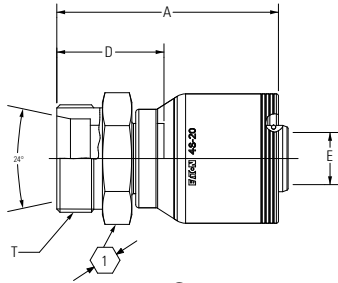

4S

# Part Number	Tube O.D.	Hose Size		Thread	A		D		E Ø		1
		DN	Dash size		mm	in	mm	in	mm	in	
1T	Dash size	DN	Dash size	Metric	mm	in	mm	in	mm	in	mm
1T8EK6	12S	10	-6	M20X1,5	54	2.13	24,5	0.97	6,5	0.26	22
1T12EK8	16S	12	-8	M24X1,5	60	2.36	27	1.06	9	0.35	27
1T16EK10	20S	16	-10	M30X2	68	2.68	31,4	1.24	12	0.47	32
4S	Dash size	DN	Dash size	Metric	mm	in	mm	in	mm	in	mm
4S20EK12	25S	19	-12	M36X2	78,6	3.09	42,3	1.67	14,2	0.56	41,0
4S25EK16	30S	25	-16	M42X2	83,7	3.30	44,0	1.73	19,2	0.75	46,0
4S32EK20	38S	31	-20	M52X2	106,9	4.21	51,7	2.04	25,2	0.99	55,0

Female Swivel DIN 24° Seat (DS)

S.Rh DKO (Heavy)
Straight

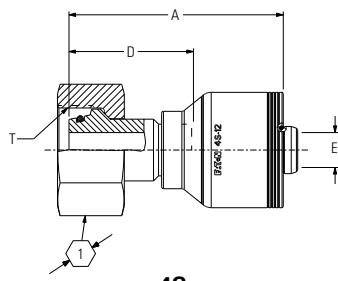

4S

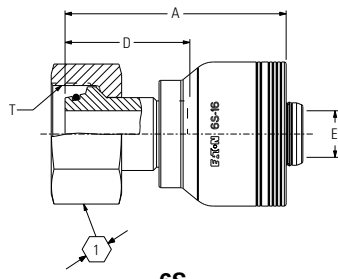

6S

# Part Number	Tube O.D.	Hose Size		Thread	A		D		E Ø		1
		DN	Dash size		mm	in	mm	in	mm	in	
1T	Dash size	DN	Dash size	Metric	mm	in	mm	in	mm	in	mm
1T8DS6	12S	10	-6	M20X1,5	58.2	2.29	28.7	1.13	6.5	0.26	24
1T12DS8	16S	12	-8	M24X1,5	61.2	2.41	28	1.10	6.5	0.26	30
1T12DS10	16S	12	-8	M24X1,5	65	2.56	32	1.26	9	0.35	30
1T16DS10	20S	16	-10	M30X2	68.5	2.70	31.9	1.26	11	0.43	36
4S	Dash size	DN	Dash size	Metric	mm	in	mm	in	mm	in	mm
4S16DS12	20S	19	-12	M30X2	73,7	2.90	37,4	1.47	14,2	0.56	36,0
4S20DS12	25S	19	-12	M36X2	86,6	3.41	50,3	1.98	14,2	0.56	46,0
4S25DS12	30S	19	-12	M42X2	88,2	3.47	51,9	2.04	14,2	0.56	50,0
4S25DS16	30S	25	-16	M42X2	91,1	3.59	51,4	2.02	19,2	0.76	50,0
4S32DS16	38S	25	-16	M52X2	94,5	3.72	55,3	2.18	19,2	0.76	60,0
4S25DS20	30S	31	-20	M42X2	96,6	3.80	41,6	1.64	22,1	0.87	50,0
4S32DS20	38S	31	-20	M52X2	111,5	4.39	56,5	2.22	25,2	0.99	60,0
6S	Dash size	DN	Dash size	Metric	mm	in	mm	in	mm	in	mm
6S25DS16	30S	25	-16	M42X2	91,1	3.59	51,4	2.02	19,2	0.76	50,0
6S32DS16	38S	25	-16	M52X2	95,0	3.74	55,3	2.18	19,2	0.76	60,0
6S32DS20	38S	31	-20	M52X2	112,5	4.43	56,5	2.22	25,2	0.99	60,0

1T/4S/6S Fitting series

Female Swivel DIN 24°Seat (DSA)

S.Rh DKO (heavy)
45° Elbow

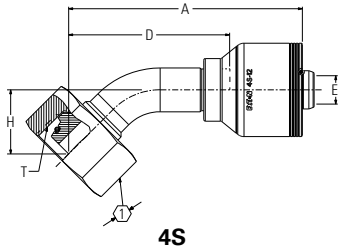

4S

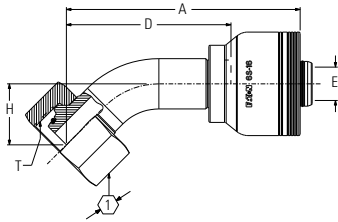

6S

# Part Number	Tube O.D.	Hose Size		Thread	A		D		E Ø		H		1
		DN	Dash size		mm	in	mm	in	mm	in	mm	in	
1T	Dash size	DN	Dash size	Metric	mm	in	mm	in	mm	in	mm	in	mm
1T8DSA6	12S	10	-6	M20X1,5	73,1	2.88	43,6	1.72	6,5	0.26	17,1	0.67	24
1T12DSA8	16S	12	-8	M24X1,5	73,7	2.90	44,2	1.74	6,5	0.26	18,2	0.72	30
1T16DSA10	20S	16	-10	M30X2	96	3.78	63	2.48	9	0.35	28,5	1.12	36
4S	Dash size	DN	Dash size	Metric	mm	in	mm	in	mm	in	mm	in	mm
4S20DSA12	25S	19	-12	M36X2	116,7	4.59	80,4	3.17	14,2	0.56	32,0	1.26	46,0
4S25DSA12	30S	19	-12	M42X2	130,8	5.15	94,4	3.72	14,2	0.56	35,0	1.38	50,0
4S25DSA16	30S	25	-16	M42X2	134,2	5.28	94,4	3.72	19,2	0.76	35,0	1.38	50,0
4S32DSA16	38S	25	-16	M52X2	145,1	5.71	105,3	4.15	19,2	0.76	39,0	1.54	60,0
4S32DSA20	38S	31	-20	M52X2	161,3	6.35	106,3	4.19	25,2	0.99	39,0	1.54	60,0
6S	Dash size	DN	Dash size	Metric	mm	in	mm	in	mm	in	mm	in	mm
6S25DSA16	30S	25	-16	M42X2	134,1	5.28	94,4	3.72	19,2	0.76	35,0	1.38	50,0
6S32DSA16	38S	25	-16	M52X2	145,1	5.71	105,3	4.15	19,2	0.76	39,0	1.54	60,0
6S32DSA20	38S	31	-20	M52X2	162,4	6.39	106,3	4.19	25,2	0.99	39,0	1.54	60,0

Female swivel DIN 24° Seat (DSB)

S.Rh DKO (heavy)
90° Elbow

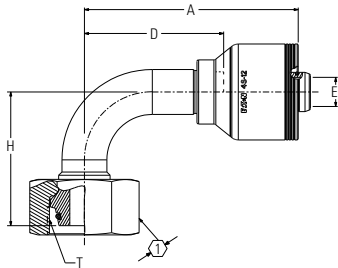

4S

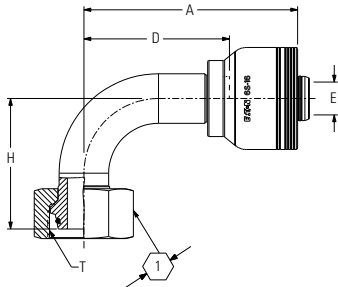

6S

# Part Number	Tube O.D.	Hose Size		Thread	A		D		E Ø		H		1
		DN	Dash size		mm	in	mm	in	mm	in	mm	in	
1T	Dash size	DN	Dash size	Metric	mm	in	mm	in	mm	in	mm	in	mm
1T8DSB6	12S	10	-6	M20X1,5	67,5	2.66	38	1.50	6,5	0.26	37	1.46	24
1T12DSB8	16S	12	-8	M24X1,5	83	3.27	50	1.97	9	0.35	55	2.17	30
1T12DSB10	16S	16	-10	M24X1,5	87	3.43	50,4	1.99	12	0.47	50	1.97	30
1T16DSB10	20S	16	-10	M30X2	92	3.62	55,4	2.18	12	0.47	61,5	2.42	36
4S	Dash size	DN	Dash size	Metric	mm	in	mm	in	mm	in	mm	in	mm
4S20DSB12	25S	19	-12	M36X2	103,9	4.09	67,7	2.67	14,2	0.56	65,0	2.56	46,0
4S25DSB12	30S	19	-12	M42X2	122,7	4.83	86,4	3.40	14,2	0.56	76,0	2.99	50,0
4S25DSB16	30S	25	-16	M42X2	124,5	4.90	84,8	3.34	19,2	0.76	76,0	2.99	50,0
4S32DSB16	38S	25	-16	M52X2	136,7	5.38	97,0	3.82	19,2	0.76	89,0	3.50	60,0
4S32DSB20	38S	31	-20	M52X2	153,0	6.02	98,0	3.86	25,2	0.99	89,0	3.50	60,0
6S	Dash size	DN	Dash size	Metric	mm	in	mm	in	mm	in	mm	in	mm
6S25DSB16	30S	25	-16	M42X2	124,5	4.90	84,8	3.34	19,2	0.76	76,0	2.99	50,0
6S32DSB16	38S	25	-16	M52X2	136,7	5.38	97,0	3.82	19,2	0.76	89,0	3.50	60,0
6S32DSB20	38S	31	-20	M52X2	154,2	6.07	98,0	3.86	25,2	0.99	89,0	3.50	60,0

1T/4S/6S Fitting series

Code 61 Flange

SAE Code 61 Flange (FL)

Straight

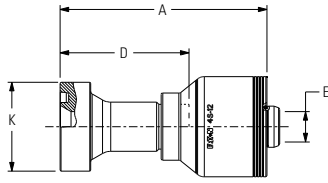

4S

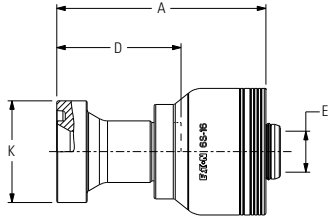

6S

# Part Number	Terminal End Dash size	Hose Size		Flange Head Dia. K Ø		A		D		E Ø	
		DN	Dash size	mm	in	mm	in	mm	in	mm	in
1T											
1T8FL8	-8	12	-8	30.2	1.19	83	3.27	50	1.97	9	0.35
1T12FL10	-12	16	-10	38.1	1.50	94	3.70	57.4	2.26	12	0.47
4S											
4S12FL12	-12	19	-12	38,1	1.50	90,7	3.57	54,5	2.15	14,2	0.56
4S16FL12	-16	19	-12	44,5	1.75	90,2	3.55	54,0	2.13	14,2	0.56
4S20FL12	-20	19	-12	50,8	2.00	97,7	3.85	61,5	2.42	14,2	0.56
4S16FL16	-16	25	-16	44,5	1.75	93,3	3.67	53,6	2.11	19,2	0.76
4S20FL16	-20	25	-16	50,8	2.00	100,8	3.97	61,1	2.41	19,2	0.76
4S24FL16	-24	25	-16	60,4	2.38	97,4	3.83	57,7	2.27	19,2	0.76
4S16FL20	-16	31	-20	44,5	1.75	110,5	4.35	55,5	2.18	25,2	0.99
4S20FL20	-20	31	-20	50,8	2.00	117,4	4.62	62,2	2.45	25,2	0.99
4S24FL20	-24	31	-20	60,4	2.38	106,7	4.20	51,6	2.03	25,2	0.99
4S32FL20	-32	31	-20	71,4	2.81	104,9	4.13	49,9	1.96	25,2	0.99
4S24FL24	-24	38	-24	60,4	2.38	171,6	6.75	93,6	3.68	31,1	1.22
4S32FL24	-32	38	-24	71,4	2.81	174,7	6.88	96,7	3.81	31,1	1.22
4S32FL32	-32	51	-32	71,4	2.81	177,5	6.99	99,5	3.92	42,1	1.66
6S											
6S16FL16	-16	25	-16	44,5	1.75	93,3	3.67	53,6	2.11	19,2	0.76
6S20FL20	-20	31	-20	50,8	2.00	118,2	4.65	62,2	2.45	25,2	0.99
6S24FL24	-24	38	-24	60,4	2.38	171,6	6.75	93,6	3.68	31,1	1.22
6S32FL24	-32	38	-24	71,4	2.81	174,7	6.88	96,7	3.81	31,1	1.22
6S32FL32	-32	51	-32	71,4	2.81	177,5	6.99	99,5	3.92	42,1	1.66

SAE Code 61 Flange (FLA)

45° Elbow

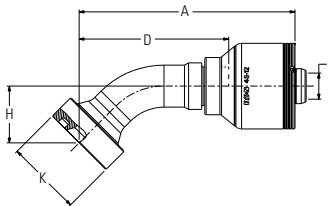

4S

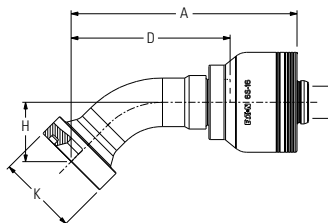

6S

# Part Number	Terminal End Dash size	Hose Size		Flange Head Dia. K Ø		A		D		E Ø		H	
		DN	Dash size	mm	in	mm	in	mm	in	mm	in	mm	in
1T													
1T8FLA8	-8	12	-8	30.2	1.9	91.7	3.61	58.7	2.31	9	0.35	23	0.91
1T12FLA10	-12	16	-10	38.1	1.50	100.7	3.97	64.1	2.53	12	0.47	25.3	1.00
4S													
4S12FLA12	-12	19	-12	38,1	1.50	113,8	4.48	77,6	3.06	14,2	0.56	27,0	1.06
4S16FLA12	-16	19	-12	44,4	1.75	127,9	5.04	91,7	3.61	14,2	0.56	32,0	1.26
4S12FLA16	-12	25	-16	38,1	1.50	116,9	4.60	77,2	3.04	19,2	0.76	27,0	1.06
4S16FLA16	-16	25	-16	44,4	1.75	131,0	5.16	91,3	3.59	19,2	0.76	32,0	1.26
4S20FLA16	-16	31	-20	44,4	1.75	152,1	5.99	97,0	3.82	25,2	0.99	32,0	1.26
4S16FLA20	-20	25	-16	50,8	2.00	150,2	5.91	110,5	4.35	19,2	0.76	39,0	1.54
4S20FLA20	-20	31	-20	50,8	2.00	166,8	6.57	111,6	4.39	25,2	0.99	39,0	1.54
4S24FLA20	-24	31	-20	60,4	2.38	161,6	6.36	106,6	4.20	25,2	0.99	39,5	1.34
4S24FLA24	-24	38	-24	60,3	2.37	214,3	8.44	136,3	5.37	31,1	1.22	45,0	1.77
4S32FLA24	-32	38	-24	71,4	2.81	251,0	9.88	173,0	6.81	31,1	1.22	57,5	2.26
4S32FLA32	-32	51	-32	71,4	2.81	253,9	10.00	175,9	6.92	42,1	1.66	57,5	2.26
6S													
6S16FLA16	-16	25	-16	44,4	1.75	131,0	5.16	91,3	3.59	19,2	0.76	32,0	1.26
6S20FLA16	-20	25	-16	50,8	2.00	150,2	5.91	110,5	4.35	19,2	0.76	39,0	1.54
6S20FLA20	-20	31	-20	50,8	2.00	167,6	6.60	111,6	4.39	25,2	0.99	39,0	1.54
6S24FLA24	-24	38	-24	60,3	2.37	214,3	8.44	136,3	5.37	31,1	1.22	45,0	1.77
6S32FLA24	-32	38	-24	71,4	2.81	251,0	9.88	173,0	6.81	31,1	1.22	57,5	2.26
6S32FLA32	-32	51	-32	71,4	2.81	253,9	10.00	175,9	6.92	42,1	1.66	57,5	2.26

1T/4S/6S Fitting series

SAE Code 61 Flange (FLB)

90° Elbow

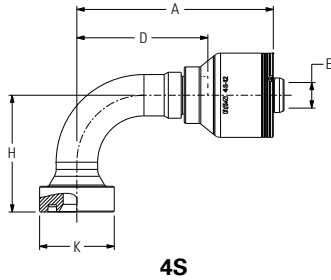

4S

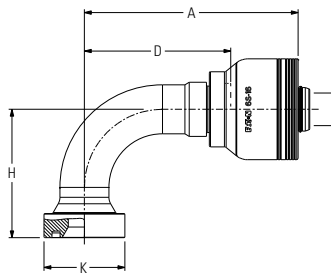

6S

# Part Number	Terminal End	Hose Size		Flange Head Dia. K Ø		A		D		E Ø		H	
		DN	Dash size	mm	in	mm	in	mm	in	mm	in	mm	in
1T	Dash size	DN	Dash size	mm	in	mm	in	mm	in	mm	in	mm	in
1T8FLB8	-8	12	-8	30,2	1.19	83,5	3.29	50	1.97	9	0.35	47	1.58
1T12FLB10	-12	16	-10	38,1	1.50	93,3	3.68	56,7	2.23	12	0.47	53,8	2.12
4S	Dash size	DN	Dash size	mm	in	mm	in	mm	in	mm	in	mm	in
4S12FLB12	-12	19	-12	38,1	1.50	108,5	4.27	72,3	2.85	14,2	0.56	59,0	2.32
4S16FLB12	-16	19	-12	44,4	1.75	122,8	4.84	86,6	3.41	14,2	0.56	71,0	2.80
4S20FLB12	-20	19	-12	50,8	2.00	108,5	4.72	72,3	2.85	14,2	0.56	65,0	2.56
4S16FLB16	-16	25	-16	44,4	1.75	126,0	4.96	86,2	3.39	19,2	0.76	71,0	2.80
4S16FLB16.116	-16	25	-16	44,4	1.75	126,0	4.96	86,2	3.39	19,2	0.76	116,0	4.57
4S20FLB16	-20	25	-16	50,8	2.00	145,2	5.72	105,4	4.15	19,2	0.76	89,0	3.50
4S24FLB16	-24	25	-16	60,4	2.38	136,5	5.37	96,8	3.81	19,2	0.76	81,9	3.22
4S16FLB20	-16	31	-20	44,4	1.75	147,1	5.79	91,9	3.62	25,2	0.99	71,0	2.80
4S20FLB20	-20	31	-20	50,8	2.00	161,8	6.37	106,5	4.19	25,2	0.99	89,0	3.50
4S24FLB20	-24	31	-20	60,4	2.38	152,9	6.02	97,9	3.85	25,2	0.99	81,9	3.22
4S24FLB24	-24	38	-24	60,3	2.37	208,9	8.22	130,9	5.15	31,1	1.22	104,0	4.09
4S32FLB24	-32	38	-24	71,4	2.81	247,4	9.74	169,4	6.67	31,1	1.22	138,0	5.43
4S32FLB32	-32	51	-32	71,4	2.81	250,3	9.85	172,2	6.78	42,1	1.66	138,0	5.43
6S	Dash size	DN	Dash size	mm	in	mm	in	mm	in	mm	in	mm	in
6S16FLB16	-16	25	-16	44,4	1.75	126,0	4.96	86,2	3.39	19,2	0.76	71,0	2.80
6S20FLB16	-20	25	-16	50,8	2.00	145,2	5.72	105,4	4.15	19,2	0.76	89,0	3.50
6S20FLB20	-20	31	-20	50,8	2.00	162,5	6.40	106,5	4.19	25,2	0.99	89,0	3.50
6S24FLB24	-24	38	-24	60,3	2.37	208,8	8.22	130,8	5.15	31,1	1.22	104,0	4.09
6S32FLB24	-32	38	-24	71,4	2.81	247,4	9.74	169,4	6.67	31,1	1.22	138,0	5.43
6S32FLB32	-32	51	-32	71,4	2.81	250,3	9.85	172,2	6.78	42,1	1.66	138,0	5.43

1T/4S/6S Fitting series

Code 62 Flange

SAE Code 62 Flange (FH)

Straight

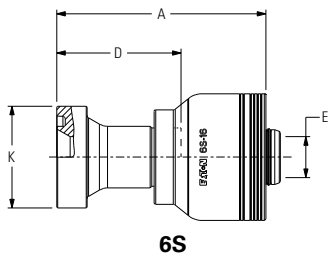
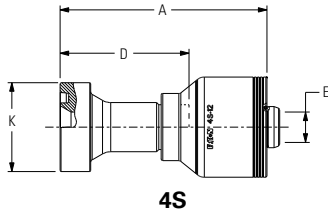

# Part Number	Terminal End	Hose Size		Flange Head Dia. K Ø		A		D		E Ø	
		DN	Dash size	mm	in	mm	in	mm	in	mm	in
1T	Dash size	DN	Dash size	mm	in	mm	in	mm	in	mm	in
1T8FH8	-8	12	-8	31.8	1.25	80.7	3.18	47.7	1.88	9	0.35
1T12FH8	-12	12	-8	41.3	1.63	84.5	3.33	51.5	2.03	9	0.35
1T8FH10	-8	16	-10	31.8	1.25	87.2	3.44	50.6	1.99	12	0.47
1T12FH10	-12	16	-10	41.3	1.63	90.5	3.57	53.9	2.12	12	0.47
1T16FH10	-16	16	-10	47.6	1.87	104.5	4.11	67.9	2.68	12.1	0.48
4S	Dash size	DN	Dash size	mm	in	mm	in	mm	in	mm	in
4S12FH12	-12	19	-12	41,3	1.63	90,7	3.57	54,5	2.15	14,2	0.56
4S16FH12	-16	19	-12	47,7	1.88	90,2	3.55	54,0	2.13	14,2	0.56
4S12FH16	-12	25	-16	41,3	1.63	96,3	3.79	56,7	2.23	14,2	0.56
4S16FH16	-16	25	-16	47,7	1.88	98,9	3.89	59,1	2.33	19,2	0.76
4S20FH16	-20	25	-16	54,0	2.13	100,8	3.97	61,0	2.40	19,2	0.76
4S16FH20	-16	31	-20	47,7	1.88	123,8	4.87	68,6	2.70	25,2	0.99
4S20FH20	-20	31	-20	54,0	2.13	123,3	4.85	68,1	2.68	25,2	0.99
4S24FH20	-24	31	-20	63,5	2.50	129,0	5.08	73,9	2.91	25,2	0.99
4S24FH24	-24	38	-24	63,5	2.50	189,6	7.46	111,6	4.39	31,1	1.22
4S32FH24	-32	38	-24	79,4	3.13	204,4	8.05	126,4	4.89	31,1	1.22
4S32FH32	-32	51	-32	79,4	3.13	202,7	7.98	124,7	4.91	42,1	1.66
6S	Dash size	DN	Dash size	mm	in	mm	in	mm	in	mm	in
6S16FH16	-16	25	-16	47,7	1.88	98,8	3.89	59,2	2.33	19,2	0.76
6S20FH16	-20	25	-16	54,0	2.13	100,8	3.97	61,0	2.40	19,2	0.76
6S20FH20	-20	31	-20	54,0	2.13	124,0	4.88	68,1	2.68	25,2	0.99
6S24FH20	-24	31	-20	63,5	2.50	129,8	5.11	73,9	2.91	25,2	0.99
6S24FH24	-24	38	-24	63,5	2.50	189,6	7.46	111,6	4.39	31,1	1.22
6S32FH24	-32	38	-24	79,4	3.13	204,4	8.05	126,4	4.98	31,1	1.22
6S32FH32	-32	51	-32	79,4	3.13	202,7	7.98	124,7	4.91	42,1	1.66

1T/4S/6S Fitting series

SAE Code 62 Flange (FHA)

45° Elbow

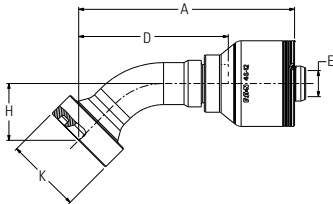

4S

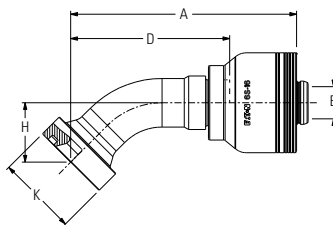

6S

# Part Number	Terminal End	Hose Size		Flange Head Dia. K Ø		A		D		E Ø		H	
		DN	Dash size	mm	in	mm	in	mm	in	mm	in	mm	in
1T	Dash size	DN	Dash size	mm	in	mm	in	mm	in	mm	in	mm	in
1T8FHA8	-8	12	-8	31,8	1,25	90,1	3,55	57,1	2,25	9	0,35	21,3	0,84
1T12FHA8	-12	12	-8	41,3	1,62	92,8	3,66	59,8	2,36	9	0,35	23,9	0,94
1T8FHA10	-8	16	-10	31,8	1,25	94,1	3,71	57,5	2,27	12	0,47	21,3	0,84
1T12FHA10	-12	16	-10	41,3	1,62	101	3,98	64,4	2,54	12	0,47	25,7	1,01
4S	Dash size	DN	Dash size	mm	in	mm	in	mm	in	mm	in	mm	in
4S12FHA12	-12	19	-12	41,3	1,63	113,8	4,48	77,6	3,06	14,2	0,56	27,0	1,06
4S16FHA12	-16	19	-12	47,7	1,88	128,0	5,04	91,7	3,61	14,2	0,56	32,0	1,26
4S12FHA16	-12	25	-16	41,3	1,63	116,9	4,60	77,2	3,04	15,1	0,59	27,0	1,06
4S16FHA16	-16	25	-16	47,7	1,88	130,9	5,15	91,2	3,59	19,2	0,76	32,0	1,26
4S20FHA16	-20	25	-16	54,0	2,13	150,2	5,91	110,5	4,35	19,2	0,76	39,0	1,54
4S20FHA20	-20	31	-20	54,0	2,13	166,6	6,56	111,6	4,39	25,2	0,99	39,0	1,54
4S24FHA20	-24	31	-20	63,5	2,50	183,2	7,21	128,2	5,05	25,2	0,99	45,0	1,77
4S24FHA24	-24	38	-24	63,5	2,50	214,1	8,43	136,1	5,36	31,1	1,22	45,0	1,77
4S32FHA24	-32	38	-24	79,4	3,13	251,0	9,88	173,0	6,81	31,1	1,22	57,5	2,26
4S32FHA32	-32	51	-32	79,4	3,13	253,9	10,00	175,9	6,93	42,1	1,66	57,5	2,26
6S	Dash size	DN	Dash size	mm	in	mm	in	mm	in	mm	in	mm	in
6S16FHA16	-16	25	-16	47,7	1,88	130,9	5,15	91,2	3,59	19,2	0,76	32,0	1,26
6S20FHA16	-20	25	-16	54,0	2,13	150,2	5,91	110,0	4,35	19,0	0,75	39,0	1,54
6S20FHA20	-20	31	-20	54,0	2,13	167,6	6,60	111,6	4,39	25,2	0,99	39,0	1,54
6S24FHA20	-24	31	-20	63,5	2,50	184,2	7,25	128,2	5,05	25,2	0,99	45,0	1,77
6S24FHA24	-24	38	-24	63,5	2,50	214,1	8,43	136,1	5,36	31,1	1,22	45,0	1,77
6S32FHA24	-32	38	-24	79,4	3,13	251,0	9,88	173,0	6,81	31,1	1,22	57,5	2,26
6S32FHA32	-32	51	-32	79,4	3,13	253,9	10,00	175,9	6,93	42,1	1,66	57,5	2,26

1T/4S/6S Fitting series

SAE Code 62 Flange (FHB)

90° Elbow

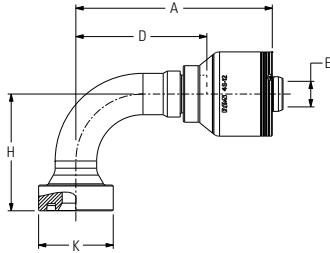

4S

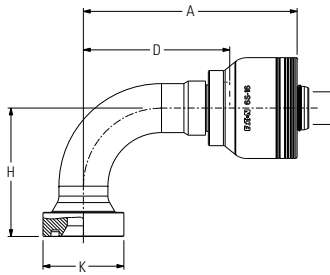

6S

# Part Number	Terminal End	Hose Size		Flange Head Dia. K Ø		A		D		E Ø		H	
		DN	Dash size	mm	in	mm	in	mm	in	mm	in	mm	in
1T	Dash size	DN	Dash size	mm	in	mm	in	mm	in	mm	in	mm	in
1T8FHB8	-8	12	-8	31,8	1,25	83,5	3,29	50,5	1,99	9	0,35	44,7	1,76
1T12FHB8	-12	12	-8	41,8	1,64	83,5	3,29	50,5	1,99	9	0,35	78	3,07
1T8FHB10	-8	16	-10	31,8	1,25	87,5	3,45	50,9	2,01	12	0,47	44,7	1,76
1T12FHB10	-12	16	-10	41,3	1,62	92,5	3,64	56,5	2,23	12	0,47	53,5	2,11
4S	Dash size	DN	Dash size	mm	in	mm	in	mm	in	mm	in	mm	in
4S12FHB12	-12	19	-12	41,3	1,63	108,5	4,27	72,3	2,85	14,2	0,56	59,0	2,32
4S16FHB12	-16	19	-12	47,7	1,88	122,9	4,84	86,6	3,41	14,2	0,56	71,0	2,80
4S16FHB16	-16	25	-16	47,7	1,88	125,5	4,94	86,1	3,39	19,2	0,76	71,0	2,80
4S16FHB16.120	-16	25	-16	47,7	1,88	126,0	4,96	86,2	3,39	19,2	0,76	120,0	4,72
4S20FHB16	-20	25	-16	54,0	2,13	145,3	5,72	105,4	4,15	19,2	0,76	89,0	3,50
4S16FHB20	-16	31	-20	47,7	1,88	147,1	5,79	91,9	3,62	25,2	0,99	71,0	2,80
4S20FHB20	-20	31	-20	54,0	2,13	161,5	6,36	106,5	4,19	25,2	0,99	89,0	3,50
4S20FHB20.120	-20	31	-20	54,0	2,13	161,5	6,36	106,5	4,19	25,2	0,99	120,0	4,72
4S24FHB20	-24	31	-20	63,5	2,50	178,0	7,01	123,0	4,84	25,2	0,99	104,0	4,09
4S24FHB24	-24	38	-24	63,5	2,50	208,9	8,22	130,8	5,15	31,1	1,22	104,0	4,09
4S32FHB24	-32	38	-24	79,4	3,13	247,4	9,74	169,4	6,67	31,1	1,22	138,0	5,43
4S32FHB32	-32	51	-32	79,4	3,13	250,3	9,85	172,2	6,78	42,1	1,66	138,0	5,43
6S	Dash size	DN	Dash size	mm	in	mm	in	mm	in	mm	in	mm	in
6S16FHB16	-16	25	-16	47,7	1,88	125,5	4,94	86,1	3,39	19,2	0,76	71,0	2,80
6S20FHB16	-20	25	-16	54,0	2,13	145,3	5,72	105,4	4,15	19,2	0,76	89,0	3,50
6S16FHB20	-16	31	-20	47,7	1,88	147,9	5,82	91,9	3,62	25,2	0,99	71,0	2,80
6S20FHB20	-20	31	-20	54,0	2,13	162,5	6,40	106,5	4,19	25,2	0,99	89,0	3,50
6S24FHB20	-24	31	-20	63,5	2,50	179,0	7,05	123,0	4,84	25,2	0,99	104,0	4,09
6S24FHB24	-24	38	-24	63,5	2,50	208,9	8,22	130,8	5,15	31,1	1,22	104,0	4,09
6S32FHB24	-32	38	-24	79,4	3,13	247,4	9,74	169,4	6,67	31,1	1,22	138,0	5,43
6S32FHB32	-32	51	-32	79,4	3,13	250,3	9,85	172,2	6,78	42,1	1,66	138,0	5,43

1T/4S/6S Fitting series

CAT® Flange

CAT® Flange (CT)

Straight

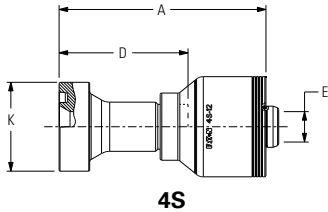

4S

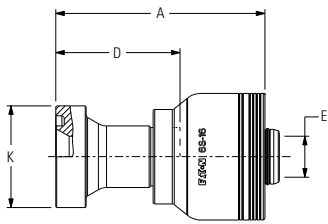

6S

# Part Number	Terminal End Dash size	Hose Size		Flange Head Dia. K Ø		A		D		E Ø	
		DN	Dash size	mm	in	mm	in	mm	in	mm	in
4S12CT12	-12	19	-12	41,3	1.63	96,2	3.79	60,0	2.36	14,2	0.56
4S16CT12	-16	19	-12	47,6	1.87	94,9	3.74	58,7	2.31	14,2	0.56
4S16CT16	-16	25	-16	47,6	1.87	102,1	4.02	62,3	2.45	19,2	0.76
4S20CT16	-20	25	-16	54,0	2.13	104,8	4.13	65,0	2.56	19,2	0.76
4S20CT20	-20	31	-20	54,0	2.13	124,5	4.90	69,1	2.72	25,2	0.99
4S24CT20**	-24	31	-20	63,5	2.50	130,9	5.15	75,9	2.99	25,2	0.99
4S24CT24	-24	38	-24	63,5	2.50	195,0	7.68	117,0	4.61	31,1	1.22
4S32CT24	-32	38	-24	79,4	3.13	206,0	8.11	128,0	5.04	31,1	1.22
4S32CT32	-32	51	-32	79,4	3.13	208,9	8.22	130,9	5.15	42,1	1.66
# Part Number	Terminal End Dash size	DN	Dash size	mm	in	mm	in	mm	in	mm	in
6S16CT16	-16	25	-16	47,6	1.87	102,1	4.02	62,3	2.45	19,2	0.76
6S20CT16	-20	25	-16	54,0	2.13	104,8	4.13	65,0	2.56	19,2	0.76
6S20CT20	-20	31	-20	54,0	2.13	125,2	4.93	69,1	2.72	25,2	0.99
6S24CT20	-24	31	-20	63,5	2.50	131,8	5.19	75,9	2.99	25,2	0.99
6S24CT24	-24	38	-24	63,5	2.50	195,0	7.68	117,0	4.61	31,1	1.22
6S32CT24	-32	38	-24	79,4	3.13	206,0	8.11	128,1	5.04	31,1	1.22
6S32CT32	-32	51	-32	79,4	3.13	208,9	8.22	130,9	5.15	42,1	1.66

** Note: Items will be available in the near future. Communication will be sent when available.

CAT® Flange (CTA)

45° Elbow

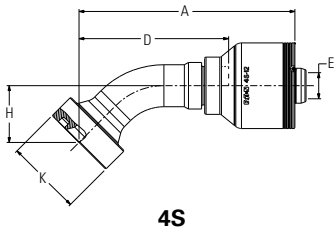

4S

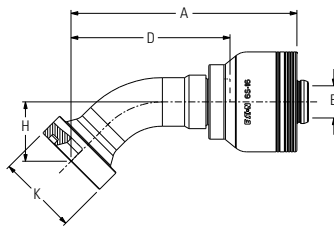

6S

# Part Number	Terminal End Dash size	Hose Size		Flange Head Dia. K Ø		A		D		E Ø		H	
		DN	Dash size	mm	in	mm	in	mm	in	mm	in	mm	in
4S12CTA12	-12	19	-12	41,3	1.63	117,7	4.63	81,5	3.21	14,2	0.56	30,9	1.22
4S16CTA12	-16	19	-12	47,6	1.87	131,2	5.17	95,0	3.74	14,2	0.56	35,3	1.39
4S16CTA16	-16	25	-16	47,6	1.87	134,3	5.29	94,6	3.72	19,2	0.76	35,3	1.39
4S20CTA16	-20	25	-16	54,0	2.13	153,0	6.02	113,2	4.46	19,2	0.76	41,8	1.65
4S20CTA20	-20	31	-20	54,0	2.13	169,4	6.67	114,3	4.50	25,2	0.99	41,8	1.65
4S24CTA20**	-24	31	-20	63,5	2.50	185,3	7.30	129,1	5.08	25,2	0.99	46,2	1.82
4S24CTA24	-24	38	-24	63,5	2.50	215,2	8.47	137,2	5.40	31,1	1.22	46,2	1.82
4S32CTA32	-32	51	-32	79,4	3.13	255,1	10.04	177,0	6.97	42,1	1.66	58,7	1.31
# Part Number	Terminal End Dash size	DN	Dash size	mm	in	mm	in	mm	in	mm	in	mm	in
6S16CTA16	-16	25	-16	47,6	1.87	134,3	5.29	94,6	3.72	19,2	0.76	35,3	1.39
6S20CTA16	-20	25	-16	54,0	2.13	153,0	6.02	113,2	4.46	19,2	0.76	41,8	1.65
6S20CTA20	-20	31	-20	54,0	2.13	170,3	6.70	114,3	4.50	25,2	0.99	41,8	1.65
6S24CTA20	-24	31	-20	63,5	2.50	185,3	7.30	129,1	5.08	25,2	0.99	46,2	1.82
6S24CTA24	-24	38	-24	63,5	2.50	215,2	8.47	137,2	5.40	31,1	1.22	46,2	1.82
6S32CTA24	-32	38	-24	79,4	3.13	252,2	9.93	174,2	6.86	31,1	1.22	58,7	2.31
6S32CTA32	-32	51	-32	79,4	3.13	255,1	10.04	177,0	6.97	42,1	1.66	58,7	2.31

** Note: Items will be available in the near future. Communication will be sent when available.

1T/4S/6S Fitting series

CAT® Flange (CTB)

90° Elbow

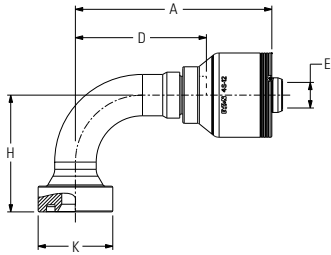

4S

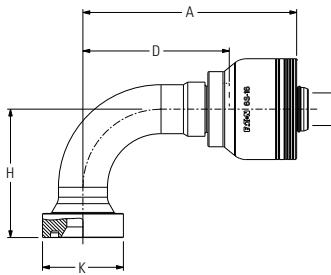

6S

# Part Number	Terminal End	Hose Size		Flange Head Dia. K Ø		A		D		E Ø		H	
		DN	Dash size	mm	in	mm	in	mm	in	mm	in	mm	in
4S12CTB12	-12	19	-12	41,3	1.63	108,5	4.27	72,3	2.85	14,2	0.56	64,5	2.54
4S16CTB12	-16	19	-12	47,6	1.87	122,8	4.83	86,6	3.41	14,2	0.56	75,7	2.98
4S16CTB16	-16	25	-16	47,6	1.87	126,0	4.96	86,2	3.39	19,2	0.76	75,7	2.98
4S20CTB16	-20	25	-16	54,0	2.13	145,2	5.72	105,4	4.15	19,2	0.76	92,9	3.66
4S20CTB20	-20	31	-20	54,0	2.13	161,5	6.36	106,5	4.19	25,2	0.99	92,9	3.66
4S24CTB20**	-24	31	-20	63,5	2.50	179,0	7.05	123,0	4.84	25,2	0.99	105,6	4.16
4S24CTB24	-24	38	-24	63,5	2.50	208,9	8.22	130,9	5.15	31,1	1.22	105,7	4.16
4S32CTB32	-32	51	-32	79,4	3.13	250,3	9.85	172,2	6.78	42,1	1.66	139,7	5.50
6S	Dash size	DN	Dash size	mm	in	mm	in	mm	in	mm	in	mm	in
6S16CTB16	-16	25	-16	47,6	1.87	126,0	4.96	86,2	3.39	19,2	0.76	75,7	2.98
6S20CTB16	-20	25	-16	54,0	2.13	145,2	5.72	105,4	4.15	19,2	0.76	92,9	3.66
6S20CTB20	-20	31	-20	54,0	2.13	162,5	6.40	106,5	4.19	25,2	0.99	92,9	3.66
6S24CTB20	-24	31	-20	63,5	2.50	179,0	7.05	123,0	4.84	25,2	0.99	105,6	4.16
6S24CTB24	-24	38	-24	63,5	2.50	208,9	8.22	130,9	5.15	31,1	1.22	105,7	4.16
6S32CTB24	-32	38	-24	69,6	2.74	247,4	9.74	169,4	6.67	31,1	1.22	139,7	5.50
6S32CTB32	-32	51	-32	79,4	3.13	250,3	9.85	172,2	6.78	42,1	1.66	139,7	5.50

** Note: Items will be available in the near future. Communication will be sent when available.

1T/4S/6S Fitting series

JIC

Female JIC/37° Swivel (FJ)

Straight

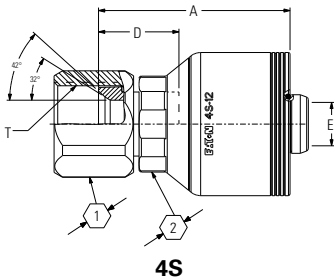

4S

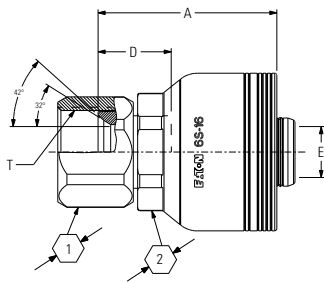

6S

# Part Number	Terminal End	Hose Size	Thread	A		D		E Ø		1
1T	Dash size	DN Dash size	in	mm	in	mm	in	mm	in	mm
1T6FJ6	-6	10 -6	9/16 -18	47	1.85	17.5	0.69	6.5	0.2561	17
1T8FJ6	-8	10 -6	3/4 -16	49	1.93	19	0.75	6.5	0.2561	22
1T8FJ8	-8	12 -8	3/4 -16	52.5	2.07	19.5	0.77	9	0.3546	22
1T10FJ8	-10	12 -8	7/8 -14	54	2.13	21	0.83	9	0.3546	27
1T10FJ10	-10	16 -10	7/8 -14	59.5	2.34	22.9	0.90	12	0.4728	27
1T12FJ10	-12	16 -10	1 1/16 -12	57	2.25	20	0.79	12	0.4728	32

# Part Number	Terminal End	Hose Size	Thread	A		D		E Ø		2	1	
4S	Dash size	DN Dash size	in	mm	in	mm	in	mm	in	mm	mm	
4S10FJ12	-10	19 -12	7/8-14	75,0	2.95	38,8	1.53	12,3	0.48	30,0	1 3/16	27
4S12FJ12	-12	19 -12	1 1/16-12	82,0	3.23	45,7	1.80	14,2	0.56	30,0	1 3/16	32
4S14FJ12	-14	19 -12	1 3/16-12	77,5	3.05	41,3	1.63	14,2	0.56	30,0	1 3/16	36
4S16FJ12	-16	19 -12	1 5/16-12	80,2	3.16	44,0	1.73	14,2	0.56	30,0	1 3/16	41
4S12FJ16	-12	25 -16	1 1/16-12	78,8	3.10	39,1	1.54	15,5	0.61	41,0	1 5/8	32
4S16FJ16	-16	25 -16	1 5/16-12	89,2	3.51	49,3	1.94	19,2	0.76	41,0	1 5/8	41
4S20FJ16	-20	25 -16	1 5/8-12	85,8	3.38	46,0	1.81	19,2	0.76	41,0	1 5/8	50
4S16FJ20	-16	31 -20	1 5/16-12	99,1	3.90	43,7	1.72	25,2	0.99	46,0	1 13/16	41
4S20FJ20	-20	31 -20	1 5/8-12	101,6	4.00	46,3	1.82	25,2	0.99	46,0	1 13/16	50
4S24FJ20	-24	31 -20	1 7/8-12	106,8	4.20	51,5	2.03	25,2	0.99	46,0	1 13/16	55
4S24FJ24	-24	38 -24	1 7/8-12	134,9	5.31	56,8	2.24	31,1	1.22	57,0	2 1/4	55
4S32FJ32	-32	51 -32	2 1/2-12	146,0	5.75	68,0	2.68	42,1	1.66			75
6S	Dash size	DN Dash size	in	mm	in	mm	in	mm	in	mm	mm	
6S16FJ16	-16	25 -16	1 5/16-12	89,2	3.51	49,3	1.94	19,2	0.76	41,0	1 5/8	41
6S20FJ20	-20	31 -20	1 5/8-12	102,3	4.03	46,3	1.82	25,2	0.99	46,0	1 13/16	50
6S24FJ20	-24	31 -20	1 7/8-12	107,5	4.23	51,5	2.03	25,2	0.99	46,0	1 13/16	55
6S24FJ24	-24	38 -24	1 7/8-12	134,9	5.31	56,8	2.24	31,1	1.22	57,0	2 1/4	55
6S32FJ32	-32	51 -32	2 1/2-12	146,0	5.75	68,0	2.68	42,1	1.66			75

⚠ Refer to note below.

⚠ When assembled with all Eaton components, all SAE 37° JIC male and female terminal ends in the 4S & 6S product line are rated at the pressures listed in the table above and have passed one million impulse cycles at 133% of this pressure. All straight configurations achieve a 4:1 burst. The 45° and 90° elbow configurations in the -12 size meet a 3.2:1 burst the 45° and 90° elbow configurations in the -16 size achieve a 2.8:1 burst; the 45° and 90° elbow configurations in the -20 size meet a 4:1 burst and the 45° & 90° elbow configurations in the -24 size meet a 2.4:1 burst.

1T/4S/6S Fitting series

Female JIC/37° Swivel (FJA)

45° Elbow

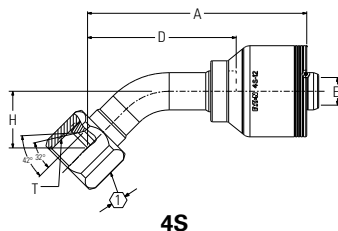

# Part Number	Terminal End Dash size	Hose Size		Thread in	A		D		E Ø		H		1
		DN	Dash size		mm	in	mm	in	mm	in	mm	in	
1T													
1T6FJA6	-6	10	-6	9/16 - 18	64.9	2.56	35.4	1.39	6.6	0.26	13.4	0.53	17
1T8FJA8	-8	12	-8	3/4 - 16	78.2	3.08	45	1.77	9	0.35	19.7	0.78	22
1T10FJA10	-10	16	-10	7/8 - 14	97	3.82	60	2.36	12	0.47	24.5	0.97	27
4S													
4S12FJA12	-12	19	-12	1 1/16-12	112,3	4.42	76,1	3.00	14,2	0.56	29,0	1.14	32
4S16FJA12	-16	19	-12	1 5/16-12	133,6	5.26	97,5	3.84	14,2	0.56	38,0	1.50	41
4S16FJA16	-16	25	-16	1 5/16-12	128,8	5.07	89,3	3.52	19,2	0.76	38,0	1.50	41
4S20FJA16	-20	25	-16	1 5/8-12	120,1	4.73	80,4	3.17	19,2	0.75	32,0	1.26	50
4S20FJA20	-20	31	-20	1 5/8-12	135,6	5.34	80,4	3.17	25,2	0.99	32,0	1.26	50
4S24FJA24	-24	38	-24	1 7/8-12	212,0	8.35	134,0	5.28	31,1	1.22	43,0	1.69	55
6S													
6S20FJA20	-20	31	-20	1 5/8-12	136,4	5.37	80,4	3.17	25,2	0.99	32,0	1.26	50
6S24FJA24	-24	38	-24	1 7/8-12	212,0	8.35	134,0	5.28	31,1	1.22	43,0	1.69	55

⚠ Refer to note below.

Female JIC/37° Swivel (FJB)

90° Elbow

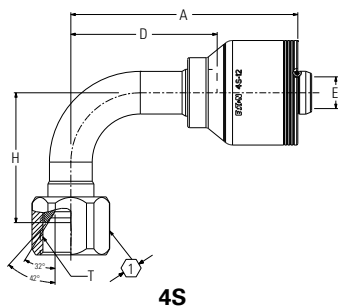

# Part Number	Terminal End Dash size	Hose Size		Thread in	A		D		E Ø		H		1
		DN	Dash size		mm	in	mm	in	mm	in	mm	in	
1T													
1T6FJB6	-6	10	-6	9/16 - 18	58	2.29	28.5	1.12	6.5	0.26	25.5	1.00	17
1T8FJB8	-8	12	-8	3/4 - 16	69	2.72	36	1.42	9	0.35	34	1.34	22
1T10FJB10	-10	16	-10	7/8 - 14	87	3.43	46.4	1.83	12	0.47	49	1.93	27
4S													
4S12FJB12	-12	19	-12	1 1/16-12	101,3	3.99	65,3	2.57	14,2	0.56	58,0	2.28	32
4S16FJB12	-16	19	-12	1 5/16-12	110,0	4.33	73,8	2.91	14,2	0.56	71,0	2.80	41
4S16FJB16	-16	25	-16	1 5/16-12	113,1	4.45	73,5	2.89	19,2	0.76	71,0	2.80	41
4S20FJB16	-20	25	-16	1 5/8-12	117,1	4.61	77,4	3.05	19,2	0.75	78,0	3.07	50
4S20FJB20	-20	31	-20	1 5/8-12	132,6	5.22	77,4	3.05	25,2	0.99	78,0	3.07	50
4S24FJB24	-24	38	-24	1 7/8-12	208,9	8.22	130,8	5.15	31,1	1.22	104,0	4.09	55
6S													
6S16FJB16	-16	25	-16	1 5/16-12	113,1	4.45	73,5	2.89	19,0	0.75	71,0	2.80	41
6S20FJB20	-20	31	-20	1 5/8-12	133,4	5.25	77,4	3.05	25,2	0.99	78,0	3.07	50
6S24FJB24	-24	38	-24	1 7/8-12	208,9	8.22	130,8	5.15	31,1	1.22	104,0	4.09	55

⚠ Refer to note below.

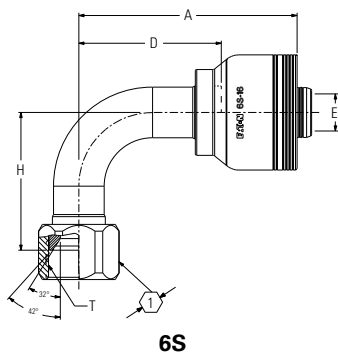

⚠ When assembled with all Eaton components, all SAE 37° JIC male and female terminal ends in the 4S & 6S product line are rated at the pressures listed in the table above and have passed one million impulse cycles at 133% of this pressure. All straight configurations achieve a 4:1 burst. The 45° and 90° elbow configurations in the -12 size meet a 3.2:1 burst the 45° and 90° elbow configurations in the -16 size achieve a 2.8:1 burst; the 45° and 90° elbow configurations in the -20 size meet a 4:1 burst and the 45° & 90° elbow configurations in the -24 size meet a 2.4:1 burst.

1T/4S/6S Fitting series

ORS

Female ORS Swivel (FR)

Straight

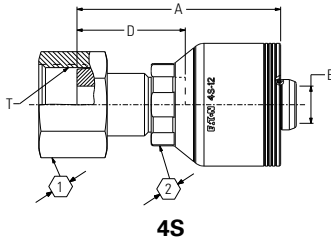

4S

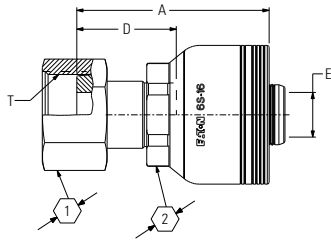

6S

# Part Number	Terminal End	Hose Size		Thread	A		D		E Ø		Ø2		Ø1
		DN	Dash size		in	mm	in	mm	in	mm	in	mm	
1T	Dash size	DN	Dash size	in	mm	in	mm	in	mm	in	mm	in	mm
1T6FR6	-6	10	-6	1 1/16-16	60,5	2.38	31	1.22	6	0.24	22	7/8	19
1T8FR8	-8	12	-8	1 3/16-16	70,5	2.78	37,5	1.48	9	0.35	24	15/16	22
1T10FR10	-10	16	-10	1-14	75,5	2.97	38,9	1.53	12	0.47	30	1 3/16	27
4S	Dash size	DN	Dash size	in	mm	in	mm	in	mm	in	mm	in	mm
4S10FR12	-10	19	-12	1-14	74,4	2.93	38,1	1.50	14,2	0.56	30,0	1 3/16	30
4S12FR12	-12	19	-12	1 3/16-12	77,4	3.05	41,2	1.62	14,2	0.56	30,0	1 3/16	36
4S16FR12	-16	19	-12	1 7/16-12	79,2	3.12	43,1	1.70	14,2	0.56	30,0	1 3/16	41
4S12FR16	-12	25	-16	1 3/16-12	80,5	3.17	40,8	1.61	19,2	0.76	41,0	1 5/8	36
4S16FR16	-16	25	-16	1 7/16-12	82,4	3.24	42,6	1.68	19,2	0.76	41,0	1 5/8	41
4S20FR16	-20	25	-16	1 11/16-12	82,4	3.24	42,7	1.68	19,2	0.76	41,0	1 5/8	50
4S20FR20	-20	31	-20	1 11/16-12	99,0	3.90	43,8	1.72	25,2	0.99	46,0	1 13/16	50
4S24FR24	-24	38	-24	2-12	125,7	4.95	47,6	1.87	31,1	1.22	57,0	2 1/4	55
6S	Dash size	DN	Dash size	in	mm	in	mm	in	mm	in	mm	in	mm
6S16FR16	-16	25	-16	1 7/16-12	82,4	3.24	42,6	1.68	19,2	0.76	41,0	1 5/8	41
6S20FR16	-20	25	-16	1 11/16-12	82,4	3.24	42,7	1.68	19,2	0.76	41,0	1 5/8	50
6S20FR20	-20	31	-20	1 11/16-12	99,8	3.93	43,8	1.72	25,2	0.99	46,0	1 13/16	50
6S24FR24	-24	38	-24	2-12	125,7	4.95	47,6	1.87	31,1	1.22	57,0	2 1/4	55

Female ORS Swivel (FRA)

45° Elbow

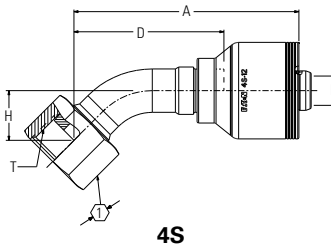

4S

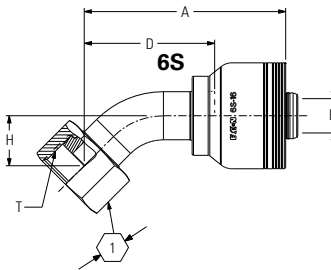

6S

# Part Number	Terminal End	Hose Size		Thread	A		D		E Ø		H		Ø1
		DN	Dash size		in	mm	in	mm	in	mm	in	mm	
1T	Dash size	DN	Dash size	in	mm	in	mm	in	mm	in	mm	in	mm
1T6FRA6	-6	10	-6	11/16-16	65	2.56	35,5	1.40	6	0.24	10,5	0.41	22
1T8FRA8	-8	12	-8	13/16-16	78,5	3.09	45,4	1.79	9	0.35	15	0.59	24
1T10FRA10	-10	16	-10	1-14	85,2	3.36	48,6	1.91	12	0.47	16,4	0.65	30
4S	Dash size	DN	Dash size	in	mm	in	mm	in	mm	in	mm	in	mm
4S12FRA12	-12	19	-12	1 3/16-12	108,7	4.28	72,5	2.85	14,2	0.56	24,0	0.94	36
4S16FRA12	-16	19	-12	1 7/16-12	119,9	4.72	83,7	3.30	14,2	0.56	28,0	1.10	41
4S16FRA16	-16	25	-16	1 7/16-12	112,8	4.44	73,0	2.87	19,2	0.76	28,0	1.10	41
4S20FRA16	-20	25	-16	1 11/16-12	136,7	5.38	97,0	3.82	19,2	0.76	31,0	1.22	50
4S20FRA20	-20	31	-20	1 11/16-12	153,4	6.04	98,1	3.86	25,2	0.99	31,0	1.22	50
4S24FRA24	-24	38	-24	2-12	212,0	8.35	134,0	5.28	31,1	1.22	43,0	1.69	55
6S	Dash size	DN	Dash size	in	mm	in	mm	in	mm	in	mm	in	mm
6S16FRA16	-16	25	-16	1 7/16-12	112,8	4.44	73,0	2.87	19,2	0.76	28,0	1.10	41
6S20FRA16	-20	25	-16	1 11/16-12	136,7	5.38	97,0	3.82	19,2	0.76	31,0	1.22	50
6S20FRA20	-20	31	-20	1 11/16-12	154,1	6.07	98,1	3.86	25,2	0.99	31,0	1.22	50
6S24FRA24	-24	38	-24	2-12	212,0	8.35	134,0	5.28	31,1	1.22	43,0	1.69	55

1T/4S/6S Fitting series

Female ORS Swivel (FRB)

90° Elbow

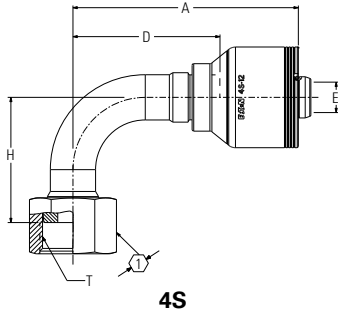

4S

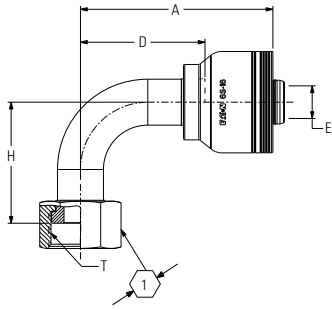

6S

# Part Number	Terminal End	Hose Size		Thread	A		D		E Ø		H		1
		DN	Dash size		in	mm	in	mm	in	mm	in	mm	
1T	Dash size	DN	Dash size	in	mm	in	mm	in	mm	in	mm	in	mm
1T6FRB6	-6	10	-6	1 3/16- 16	61,9	2.44	32,4	1.28	6,5	0.26	22,4	0.88	22
1T8FRB8	-8	12	-8	1 3/16- 16	71,7	2.82	38,7	1.52	9	0.35	29,1	1.15	24
1T10FRB10	-10	16	-10	1- 14	77,8	3.07	41,2	1.62	12	0.47	32,2	1.27	30
4S	Dash size	DN	Dash size	in	mm	in	mm	in	mm	in	mm	in	mm
4S10FRB12	-10	19	-12	1 - 14	91,5	3.60	55,3	2.18	14,2	0.56	32,3	1.27	30
4S12FRB12	-12	19	-12	1 3/16-12	104,4	4.11	68,1	2.68	14,2	0.56	58,0	2.28	36
4S16FRB12	-16	19	-12	1 7/16-12	117,1	4.61	80,9	3.19	14,2	0.56	71,0	2.80	41
4S12FRB16	-12	25	-16	1 3/16-12	107,5	4.23	67,7	2.67	19,2	0.76	58,0	2.28	36
4S16FRB16	-16	25	-16	1 7/16-12	112,8	4.44	73,0	2.87	19,2	0.76	71,0	2.80	41
4S20FRB16	-20	25	-16	1 11/16-12	136,5	5.37	96,8	3.81	19,2	0.76	78,0	3.07	50
4S20FRB20	-20	31	-20	1 11/16-12	153,1	6.03	97,9	3.85	25,2	0.99	78,0	3.07	50
4S24FRB20	-24	31	-20	2 - 12	152,9	6.02	97,9	3.85	25,2	0.99	86,0	3.39	55
4S24FRB24	-24	38	-24	2 - 12	208,9	8.22	130,8	5.15	31,1	1.22	104,0	4.09	55
6S	Dash size	DN	Dash size	in	mm	in	mm	in	mm	in	mm	in	mm
6S16FRB16	-16	25	-16	1 7/16-12	112,8	4.44	73,0	2.87	19,2	0.76	71,0	2.80	41
6S20FRB16	-20	25	-16	1 11/16-12	136,5	5.37	96,8	3.81	19,2	0.76	78,0	3.07	50
6S20FRB20	-20	31	-20	1 11/16-12	153,9	6.06	97,9	3.85	25,2	0.99	78,0	3.07	50
6S24FRB24	-24	38	-24	2 - 12	208,9	8.22	130,8	5.15	31,1	1.22	104,0	4.09	55

1T/4S/6S Fitting series

BSP 60° Cone

BSP Male Parallel Rigid (BP)

60° Cone Seat
Straight

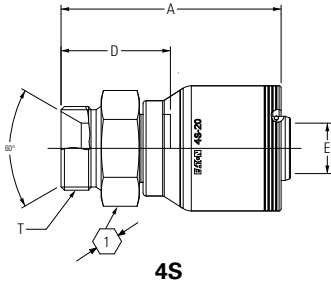

# Part Number	Terminal End Dash size	Hose Size		Thread	A		D		E Ø		1
		DN	Dash size		in	mm	in	mm	in	mm	
1T	Dash size	DN	Dash size	in	mm	in	mm	in	mm	in	mm
1T6BP6	-6	10	-8	G 3/8"	55	2.17	25.5	1.00	6.5	0.26	19
1T8BP8	-8	12	-8	G 1/2"	61	2.40	28	1.10	9	0.35	22
1T10BP10	10	16	10	G 5/8"	68	2.68	27.4	1.08	12	0.47	27
4S	Dash size	DN	Dash size	in	mm	in	mm	in	mm	in	mm
4S12BP12	-12	19	-12	G 3/4-14	79,6	3.13	43,4	1.71	14,2	0.56	32,0
4S16BP16	-16	25	-16	G 1-11	89,8	3.53	50,1	1.97	19,2	0.75	41,0
4S20BP20	-20	31	-20	G 1 1/4-11	109,7	4.32	54,5	2.15	25,1	0.99	50,0

"G" as part of thread size is ISO designation for parallel thread.

Female BSPP Swivel (BF)

60° Cone Seat
Straight

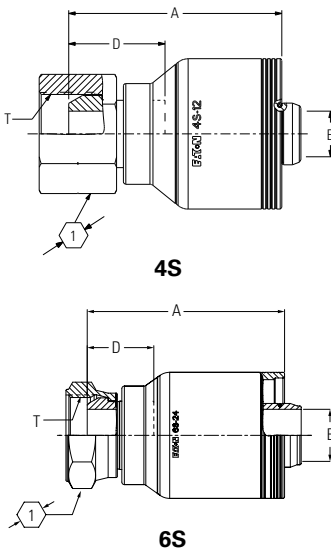

# Part Number	Terminal End Dash size	Hose Size		Thread	A		D		E Ø		1
		DN	Dash size		in	mm	in	mm	in	mm	
1T	Dash size	DN	Dash size	in	mm	in	mm	in	mm	in	mm
1T6BF6	-6	10	-6	G 3/8"	50	1.97	20.5	0.81	6.5	0.26	22
1T8BF8	-8	12	-8	G 1/2"	55.5	2.19	22.5	0.89	9	0.35	27
1T10BF10	-10	16	-10	G 5/8"	60	2.36	23.5	0.93	12	0.47	27
4S	Dash size	DN	Dash size	in	mm	in	mm	in	mm	in	mm
4S12BF12	-12	19	-12	G 3/4-14	66,2	2.61	29,9	1.18	14,2	0.56	32,0
4S16BF12	-16	19	-12	G 1-11	68,7	2.70	32,3	1.27	14,2	0.56	41,0
4S16BF16	-16	25	-16	G 1-11	71,0	2.80	32,3	1.27	19,2	0.76	41,0
4S20BF16	-20	25	-16	G 1 1/4-11	72,5	2.85	32,7	1.29	19,2	0.76	50,0
4S20BF20	-20	31	-20	G 1 1/4-11	82,8	3.26	32,7	1.29	25,2	0.99	50,0
4S24BF24	-24	38	-24	G 1 1/2-11	117,9	4.64	39,8	1.57	31,1	1.22	55,0
4S32BF32	-32	51	-32	G 2-11	121,0	4.76	43,0	1.69	42,1	1.66	70,0
6S	Dash size	DN	Dash size	in	mm	in	mm	in	mm	in	mm
6S24BF24	-24	38	-24	G 1 1/2-11	117,9	4.64	39,8	1.57	31,1	1.22	55,0
6S32BF32	-32	51	-32	G 2-11	121,0	4.76	43,0	1.69	42,1	1.66	70,0

"G" as part of thread size is ISO designation for parallel thread.

1T/4S/6S Fitting series

Female BSPP Swivel (BFA)

60° Cone Seat
45° Elbow

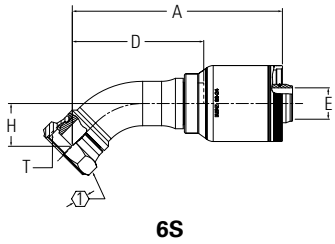
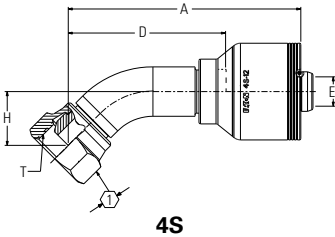

# Part Number	Terminal End	Hose Size		Thread	A		D		E Ø		H		1
		DN	Dash size		in	mm	in	mm	in	mm	in	mm	
1T	Dash size	DN	Dash size	in	mm	in	mm	in	mm	in	mm	in	mm
1T6BFA6	-6	10	-6	G 3/8"	68	2.68	38,5	1.52	6	0.24	14	0.55	22
1T8BFA8	-8	12	-8	G 1/2"	74	2.92	41	1.62	9	0.35	15	0.59	27
1T10BFA10	-10	16	-10	G 5/8"	80	3.15	43	1.69	12	0.47	16,5	0.65	30
4S	Dash size	DN	Dash size	in	mm	in	mm	in	mm	in	mm	in	mm
4S12BFA12	-12	19	-12	G 3/4-14	112,3	4.42	75,9	2.99	14,2	0.56	26,0	1.02	32,0
4S16BFA12	-16	19	-12	G 1-11	115,8	4.56	79,5	3.13	14,2	0.56	30,0	1.18	41,0
4S16BFA16	-16	25	-16	G 1-11	130,3	5.13	90,6	3.57	19,2	0.76	30,0	1.18	41,0
4S20BFA16	-20	25	-16	G 1 1/4-11	133,0	5.24	93,4	3.68	19,2	0.76	34,0	1.34	50,0
4S20BFA20	-20	31	-20	G 1 1/4-11	149,5	5.89	99,1	3.90	25,2	0.99	34,0	1.34	50,0
4S24BFA24	-24	38	-24	G 1 1/2-11	208,3	8.20	130,3	5.13	31,1	1.22	42,4	1.67	55,0
4S32BFA32	-32	51	-32	G 2-11	248,4	9.78	170,4	6.71	42,1	1.66	54,1	2.13	70,0
6S	Dash size	DN	Dash size	in	mm	in	mm	in	mm	in	mm	in	mm
6S24BFA24	-24	38	-24	G 1 1/2-11	208,3	8.20	130,3	5.13	31,1	1.22	42,4	1.67	55,0
6S32BFA32	-32	51	-32	G 2-11	248,4	9.78	170,4	6.71	42,1	1.66	54,1	2.13	70,0

"G" as part of thread size is ISO designation for parallel thread.

Female BSPP Swivel (BFB)

60° Cone Seat
90° Elbow

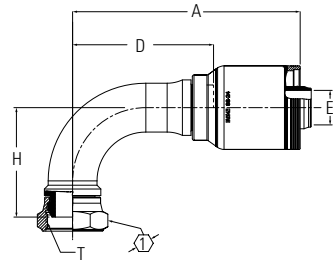
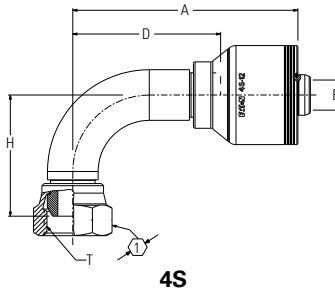

# Part Number	Terminal End	Hose Size		Thread	A		D		E Ø		H		1
		DN	Dash size		in	mm	in	mm	in	mm	in	mm	
1T	Dash size	DN	Dash size	in	mm	in	mm	in	mm	in	mm	in	mm
1T6BFB6	-6	10	-6	G 3/8"	62	2.44	32,4	1.28	6,5	0.26	28	1.10	22
1T8BFB8	-8	12	-8	G 1/2"	69,5	2.74	36,5	1.44	9	0.35	32	1.26	27
1T10BFB10	-10	16	-10	G 5/8"	76,5	3.01	39	1.54	12	0.47	36	1.42	27
4S	Dash size	DN	Dash size	in	mm	in	mm	in	mm	in	mm	in	mm
4S12BFB12	-12	19	-12	G 3/4-14	105,9	4.17	69,6	2.74	14,2	0.56	57,0	2.24	32,0
4S16BFB12	-16	19	-12	G 1-11	105,9	4.17	69,6	2.74	14,2	0.56	68,0	2.68	41,0
4S16BFB16	-16	25	-16	G 1-11	125,5	4.94	85,8	3.38	19,2	0.76	68,0	2.68	41,0
4S20BFB16	-20	25	-16	G 1 1/4-11	125,5	4.94	85,8	3.38	19,2	0.76	79,0	3.11	50,0
4S20BFB20	-20	31	-20	G 1 1/4-11	145,0	5.71	95,0	3.74	25,2	0.99	79,0	3.11	50,0
4S24BFB24	-24	38	-24	G 1 1/2-11	205,1	8.07	127,0	5.00	31,1	1.22	98,6	3.88	55,0
4S32BFB32	-32	51	-32	G 2-11	245,7	9.67	167,6	6.60	42,1	1.66	125,3	4.93	70,0
6S	Dash size	DN	Dash size	in	mm	in	mm	in	mm	in	mm	in	mm
6S24BFB24	-24	38	-24	G 1 1/2-11	205,1	8.07	127,0	5.00	31,1	1.22	98,6	3.88	55,0
6S32BFB32	-32	51	-32	G 2-11	245,7	9.67	167,6	6.60	42,1	1.66	125,3	4.93	70,0

"G" as part of thread size is ISO designation for parallel thread.

Eaton
Hydraulics Group Europe
Route de la Longeraie 7
1110 Morges
Switzerland